



U.S.A
Catalog 719-99-07/11
Supercedes 719-99-08/07

SUPER-CUSHION® AIR SPRINGS

FOR TRUCK, TRAILER AND BUS SUSPENSIONS
AND FOR CAB AND SEAT SPRINGS

SUPER-CUSHION AIR SPRINGS



GOODYEAR
ENGINEERED PRODUCTS

SELECTED NON-WARRANTABLE CONDITIONS

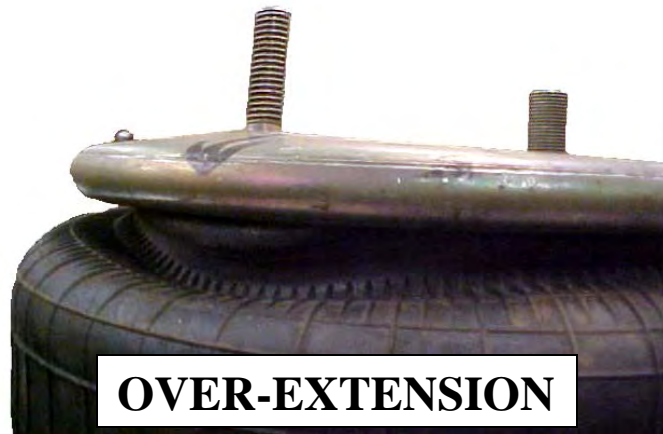

Over-Extension

- Eventual tearing away of the bellows from the top plate or the bottom piston.
- The top plate may appear convex.
- Commonly seen on lift axle applications, particularly on trucks and tractors used in severe on/off road service such as construction, logging, or quarrying.
- Results from operation of the air spring beyond its rated maximum extended height or long-term operation at or near its maximum extended height.

Possible causes:

- Improper restraint of the downward travel of the axle that allows the air spring to operate beyond its rated maximum extended height.
- The ride position is too high due to improper adjustment or improper functioning of the leveling valve.
 - Can result in long-term operation of the air spring at or near its rated maximum extended height.
- Shock absorbers are not functioning properly, are missing or are improperly sized.
- Incorrect air spring for application (too short).



Normal Cycle Fatigue

- Fatigue cracks will appear on the outer surface of the rubber as a normal part of the ageing process.
- Minor cracks are not ordinarily a cause for removal.
- The air spring will still function properly provided there is no air leakage.

SELECTED NON-WARRANTABLE CONDITIONS



DAMAGE FROM CHEMICALS

Rubber Damage from Chemicals

- Grease and oil are common examples that can cause this condition after prolonged contact with the rubber flexible member.

Possible causes:

- Excessive oil in the air supply.
- Excessive greasing of universal joints.
- Excessive greasing of the fifth wheel.
- Leaking seals in suspension components.
- Use of petroleum based cleaners on the air spring (use only soap and water for cleaning).

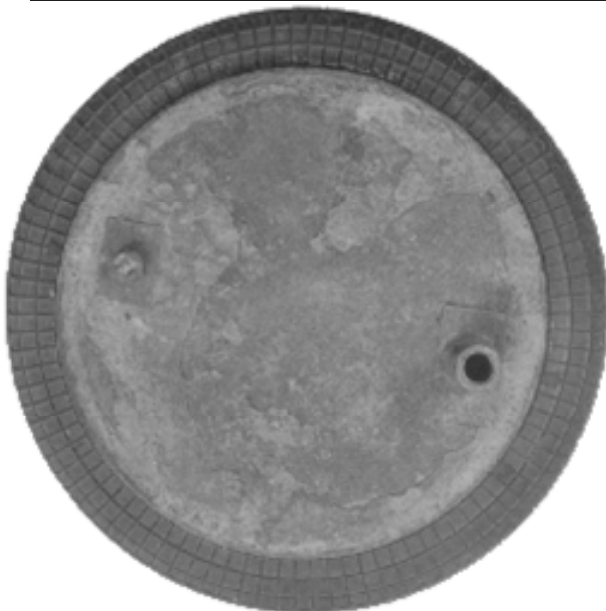

Corrosion and Impacts

- Deterioration of the top plate or piston.

Possible causes:

- Chemical exposure.
- Road debris being flung into the piston causing a crack.
- Pitting from salt.
- Excessive oil or water in the air supply.
- Build-up of debris on the piston, top plate, or girdle hoops (keep clean with soap and water).

CORROSION & IMPACTS

SELECTED NON-WARRANTABLE CONDITIONS



External Abrasion

- A hole rubbed into the side of the bellows.

Possible causes:

- Bellows contact with components on the vehicle (such as air lines).
- Road dirt and debris.
- Worn or failed parts in the suspension.
 - Worn bushing
 - Broken shock
 - misalignment
- Leak or pinch in air line causing spring to be under-inflated.

AIRSPRING BELLOWS

Part No.	Side View With Extended And Compressed Height	Upper Mounting View	Lower Mounting View	Manufacturer Numbers
1B12-301 Flexmember 578-91-3-301		ASA-92-8-002 	ASA-92-6-002 	Conti FS330-11468 FIRESTONE 7009 NEWAY 905-57-002 TRIANGLE 4468
1B12-305 Flexmember 578-91-3-301		ASA-92-8-006 	ASA-92-6-002 	FIRESTONE 6920 7043
1B12-306 Flexmember 578-91-3-301		ASA-92-8-002 	ASA-92-6-002 	
1B12-313 Flexmember 578-91-3-301		ASA-92-8-002 	ASA-92-6-002 	
1B14-350 Flexmember 578-91-3-351		ASA-92-8-028 	ASA-92-6-013 	Conti FS530-14442 FIRESTONE 7103 PEERLESS 0550-00015 TRIANGLE 4442

- - Bolt or Stud 1/2-13 or 1/2-20
- ⊗ - Air Fitting - 1/4 NPTF
- ⊙ - Stud - 3/4-10
- ⊕ - Tapped Hole on Top Retainers 3/8-16, on Pistons - 1/2-13
- ⊗ - Air Fitting - 1/2 NPTF or 3/8 NPTF
- ⊙ - Combination Stud Air Fitting Stud - 3/4-16; Air Fitting - 1/4 NPTF

Part No.	Side View With Extended And Compressed Height	Upper Mounting View	Lower Mounting View	Manufacturer Numbers
1B14-351 Flexmember 578-91-3-351		ASA-92-8-028 	ASA-92-6-013 	<u>AMERICAN CARRIER</u> 8003-007 <u>Conti</u> FS530-14446 FS530-14447 <u>FIRESTONE</u> 7105 <u>TRIANGLE</u> 4447
1B14-358 Flexmember 578-91-3-352		ASA-92-8-031 	ASA-92-6-015 	<u>Conti</u> 905-57-041 FS530-14339 AR-1834 <u>DAYTON</u> RIDEWELL 354-7112 1003587112C <u>FIRESTONE</u> S-3364-C 7112 <u>TRIANGLE</u> 4339 INT'L/ <u>NAVISTAR</u> 554782C1 <u>LOAD GUARD</u> SC2012 <u>NEWAY</u> 905-57-026 905-57-028
1B14-373 Flexmember 578-91-3-351		ASA-92-8-174 	ASA-92-6-056 	
1B8-564 Flexmember 579-91-3-532		ASC-92-8-171 	ASB-92-6-055 	
2B10-226 Flexmember 578-92-3-250		ASA-92-8-113 	ASA-92-6-010 	<u>Conti</u> FD200-22524 <u>FIRESTONE</u> 7795 <u>HENDRICKSON</u> B-14486 <u>TRIANGLE</u> 4524

- - Bolt or Stud 1/2-13 or 1/2-20
- ⊗ - Air Fitting - 1/4 NPTF
- ⊙ - Stud - 3/4-10
- ◐ - Tapped Hole on Top Retainers 3/8-16, on Pistons - 1/2-13
- ⊗ - Air Fitting - 1/2 NPTF or 3/8 NPTF
- ⊗ - Combination Stud Air Fitting Stud - 3/4-16; Air Fitting - 1/4 NPTF

AIRSPRING BELLOWS

Part No.	Side View With Extended And Compressed Height	Upper Mounting View	Lower Mounting View	Manufacturer Numbers
2B12-300 Flexmember 578-92-3-309		ASA-92-8-003 	ASA-92-6-001 	Conti FD330-22327 DAYTON 354-7424 FIRESTONE 7424 HDA PMABG-7424B INT'L/ NAVISTAR 554785C1 LOAD GUARD SC2024 NEWAY 905-57-014 TC-144-2 R & S TRUCK & BODY 1090215 SAUR AXLES (SAS) P10-755 TAURUS AS214-7424 TRIANGLE 4327 WATSON & CHALIN AS-0009
2B12-304 Flexmember 578-92-3-309		ASA-92-8-005 	ASA-92-6-006 	Conti FD330-22500 FIRESTONE 7344 FLXIBLE 6-336-13 6-336-5 SMOOTH RIDE P10-755C
2B12-305 Flexmember 578-92-3-310		ASA-92-8-026 	ASA-92-6-002 	Conti FD330-30323 DAYTON 354-7443 FIRESTONE 7443 GRANNING 1218 1589 INT'L/ NAVISTAR 554786C1 LOAD GUARD SC2026 RIDEWELL 1003587443C S-2683-C TRIANGLE 4323 WATSON & CHALIN AS-0027
2B12-307 Flexmember 578-92-3-309		ASA-92-8-017 	ASA-92-6-002 	Conti FD330-22318 DAYTON 354-7403 FIRESTONE 7403 GRANNING 2725 HDA PMABG-7403B HENDRICKSON B-1159 B-2883 INT'L/ NAVISTAR 554787C1 R & S TRUCK & BODY 1040201 1090201 RIDEWELL S-4302-C SUSPENSIONS INC. 200448 TAURUS AS214-7403 TRIANGLE 4318 WATSON & CHALIN AS-0007

- - Bolt or Stud 1/2-13 or 1/2-20
- ⊗ - Air Fitting - 1/4 NPTF
- - Stud - 3/4-10
- ◐ - Tapped Hole on Top Retainers 3/8-16, on Pistons - 1/2-13
- ⊗ - Air Fitting - 1/2 NPTF or 3/8 NPTF
- ⊗ - Combination Stud Air Fitting Stud - 3/4-16; Air Fitting - 1/4 NPTF

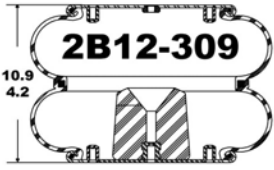
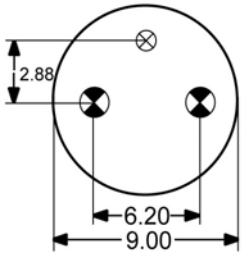
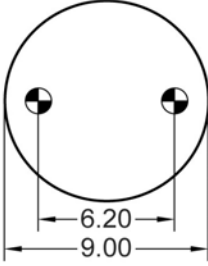
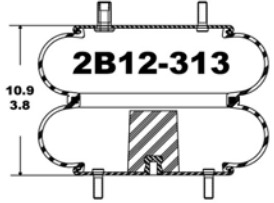
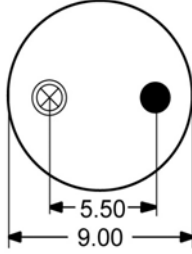
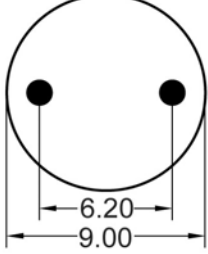
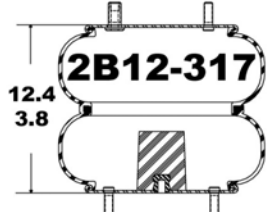
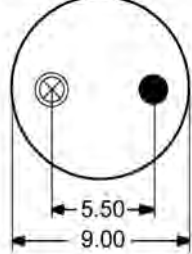
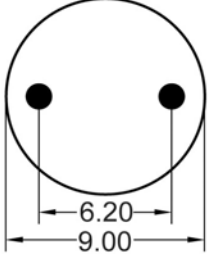
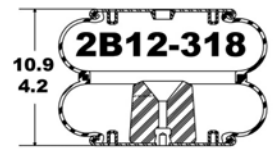
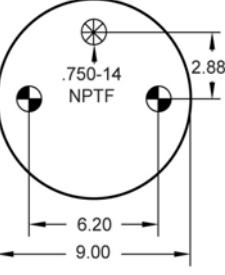
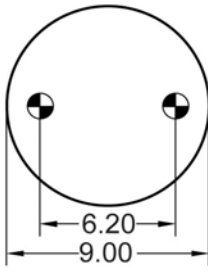
Part No.	Side View With Extended And Compressed Height	Upper Mounting View	Lower Mounting View	Manufacturer Numbers																				
2B12-309 Flexmember 578-92-3-309		ASA-92-8-002 	ASA-92-6-002 	<table border="0"> <tr> <td><u>Conti</u> FD330-22313</td> <td><u>LOAD GUARD</u> SC2020</td> </tr> <tr> <td><u>DAYTON</u> 354-7400</td> <td><u>MASA</u> 227002002</td> </tr> <tr> <td><u>FAB TEK</u> 40080</td> <td><u>NEWAY</u> 905-57-016</td> </tr> <tr> <td><u>FIRESTONE</u> 7400</td> <td><u>TC-144-4</u> <u>R & S TRUCK & BODY</u> 1027519</td> </tr> <tr> <td><u>FREIGHTLINER</u> 16-10769-000</td> <td><u>RIDEWELL</u> 693230</td> </tr> <tr> <td><u>GMC</u> 693230</td> <td><u>1003587400C</u> S-788-C</td> </tr> <tr> <td><u>GRANNING</u> 2726</td> <td><u>TAURUS</u> AS214-7400</td> </tr> <tr> <td><u>HDA</u> PMABG-7400B</td> <td><u>TRIANGLE</u> 4313</td> </tr> <tr> <td><u>HENDRICKSON</u> C-1013</td> <td><u>WATSON & CHALIN</u> AS-0003</td> </tr> <tr> <td><u>INT'L / NAVISTAR</u> 554788C1</td> <td></td> </tr> </table>	<u>Conti</u> FD330-22313	<u>LOAD GUARD</u> SC2020	<u>DAYTON</u> 354-7400	<u>MASA</u> 227002002	<u>FAB TEK</u> 40080	<u>NEWAY</u> 905-57-016	<u>FIRESTONE</u> 7400	<u>TC-144-4</u> <u>R & S TRUCK & BODY</u> 1027519	<u>FREIGHTLINER</u> 16-10769-000	<u>RIDEWELL</u> 693230	<u>GMC</u> 693230	<u>1003587400C</u> S-788-C	<u>GRANNING</u> 2726	<u>TAURUS</u> AS214-7400	<u>HDA</u> PMABG-7400B	<u>TRIANGLE</u> 4313	<u>HENDRICKSON</u> C-1013	<u>WATSON & CHALIN</u> AS-0003	<u>INT'L / NAVISTAR</u> 554788C1	
<u>Conti</u> FD330-22313	<u>LOAD GUARD</u> SC2020																							
<u>DAYTON</u> 354-7400	<u>MASA</u> 227002002																							
<u>FAB TEK</u> 40080	<u>NEWAY</u> 905-57-016																							
<u>FIRESTONE</u> 7400	<u>TC-144-4</u> <u>R & S TRUCK & BODY</u> 1027519																							
<u>FREIGHTLINER</u> 16-10769-000	<u>RIDEWELL</u> 693230																							
<u>GMC</u> 693230	<u>1003587400C</u> S-788-C																							
<u>GRANNING</u> 2726	<u>TAURUS</u> AS214-7400																							
<u>HDA</u> PMABG-7400B	<u>TRIANGLE</u> 4313																							
<u>HENDRICKSON</u> C-1013	<u>WATSON & CHALIN</u> AS-0003																							
<u>INT'L / NAVISTAR</u> 554788C1																								
2B12-313 Flexmember 578-92-3-309		ASA-92-8-004 	ASA-92-6-004 	<table border="0"> <tr> <td><u>Conti</u> FD330-22364</td> <td><u>SUSPENSIONS INC.</u> 200981</td> </tr> <tr> <td><u>DAYTON</u> 354-7405</td> <td><u>TAURUS</u> AS214-7405</td> </tr> <tr> <td><u>FIRESTONE</u> 7405</td> <td><u>TRIANGLE</u> 4364</td> </tr> <tr> <td><u>HUTCHENS IND.</u> 10384-01</td> <td></td> </tr> <tr> <td><u>INT'L / NAVISTAR</u> 1685177C1</td> <td></td> </tr> <tr> <td><u>LOAD GUARD</u> SC2073</td> <td></td> </tr> </table>	<u>Conti</u> FD330-22364	<u>SUSPENSIONS INC.</u> 200981	<u>DAYTON</u> 354-7405	<u>TAURUS</u> AS214-7405	<u>FIRESTONE</u> 7405	<u>TRIANGLE</u> 4364	<u>HUTCHENS IND.</u> 10384-01		<u>INT'L / NAVISTAR</u> 1685177C1		<u>LOAD GUARD</u> SC2073									
<u>Conti</u> FD330-22364	<u>SUSPENSIONS INC.</u> 200981																							
<u>DAYTON</u> 354-7405	<u>TAURUS</u> AS214-7405																							
<u>FIRESTONE</u> 7405	<u>TRIANGLE</u> 4364																							
<u>HUTCHENS IND.</u> 10384-01																								
<u>INT'L / NAVISTAR</u> 1685177C1																								
<u>LOAD GUARD</u> SC2073																								
2B12-317 Flexmember 578-92-3-310		ASA-92-8-004 	ASA-92-6-004 	<table border="0"> <tr> <td><u>Conti</u> FD330-30502</td> <td></td> </tr> <tr> <td><u>FIRESTONE</u> 7499</td> <td></td> </tr> <tr> <td><u>SUSPENSIONS INC.</u> 201602</td> <td></td> </tr> <tr> <td><u>TRIANGLE</u> 4502</td> <td></td> </tr> </table>	<u>Conti</u> FD330-30502		<u>FIRESTONE</u> 7499		<u>SUSPENSIONS INC.</u> 201602		<u>TRIANGLE</u> 4502													
<u>Conti</u> FD330-30502																								
<u>FIRESTONE</u> 7499																								
<u>SUSPENSIONS INC.</u> 201602																								
<u>TRIANGLE</u> 4502																								
2B12-318 Flexmember 578-92-3-309		ASA-92-8-006 	ASA-92-6-002 	<table border="0"> <tr> <td><u>FIRESTONE</u> 7185</td> <td></td> </tr> </table>	<u>FIRESTONE</u> 7185																			
<u>FIRESTONE</u> 7185																								

- - Bolt or Stud 1/2-13 or 1/2-20
- ⊗ - Air Fitting - 1/4 NPTF
- - Stud - 3/4-10
- ◐ - Tapped Hole on Top Retainers 3/8-16, on Pistons - 1/2-13
- ⊗ - Air Fitting - 1/2 NPTF or 3/8 NPTF
- ⊗ - Combination Stud Air Fitting Stud - 3/4-16; Air Fitting - 1/4 NPTF

AIRSPRING BELLOWS

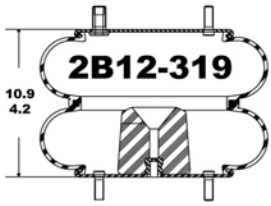
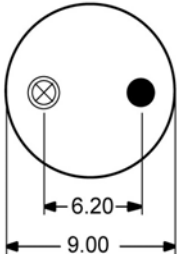
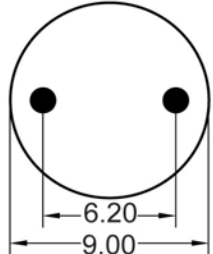
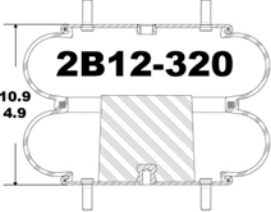
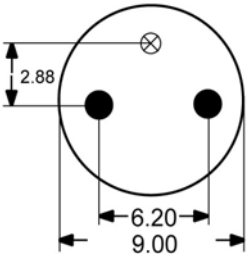
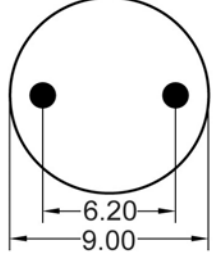
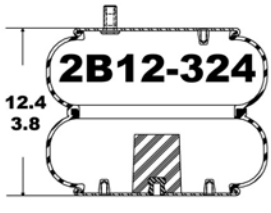
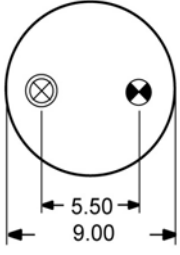
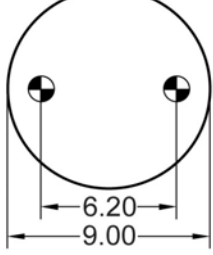
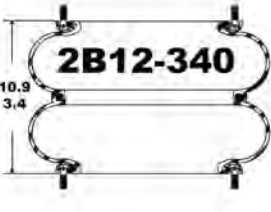
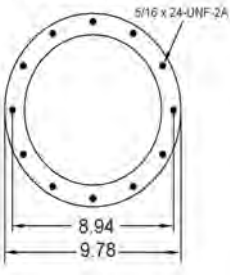
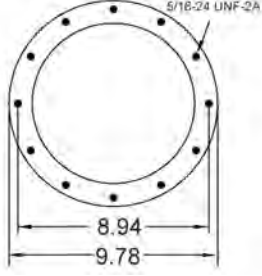
Part No.	Side View With Extended And Compressed Height	Upper Mounting View	Lower Mounting View	Manufacturer Numbers
2B12-319 Flexmember 578-92-3-309		ASA-92-8-005 	ASA-92-6-004 	Conti FD330-22367 DAYTON 354-7409 FIRESTONE 7409 INT'L/ NAVISTAR 1685178C1 LOAD GUARD SC2074 TAURUS AS214-7409 TRIANGLE 4367
2B12-320 Flexmember 578-92-3-309		ASA-92-8-003 	ASA-92-6-004 	Conti FD330-22334 DAYTON 354-7437 FIRESTONE 7401 7437 GMC 2076095 711954 HDA PMABG-7401B INT'L/ NAVISTAR 554789C1 LOAD GUARD SC2025 NEWAY 905-57-015 TC-144-3A RIDEWELL 1003587437C 1006587437C S-3363-C TAURUS AS214-7401 AS214-7437 TRIANGLE 4334 INT'L/ 4337 VOLVO 2076095 WATSON & CHALIN AS-0014
2B12-324 Flexmember 578-92-3-310		ASA-92-8-017 	ASA-92-6-002 	Conti FD330-30340 FD330-30513 DAYTON 354-7447 E-Z RIDE 8030150 FIRESTONE 7447 7790 HENDRICKSON 1475 B-6242 INT'L/ NAVISTAR 554790C1 LOAD GUARD SC2028 TRIANGLE 4340 4513
2B12-340 Flexmember 578-92-3-309		ASB-92-9-153 	ASB-92-8-153 	FIRESTONE 7124 MCI 12C-3-52 PREVOST 63-0185

- - Bolt or Stud 1/2-13 or 1/2-20
- ⊗ - Air Fitting - 1/4 NPTF
- - Stud - 3/4-10
- ⊕ - Tapped Hole on Top Retainers 3/8-16, on Pistons - 1/2-13
- ⊗ - Air Fitting - 1/2 NPTF or 3/8 NPTF
- ⊗ - Combination Stud Air Fitting Stud - 3/4-16; Air Fitting - 1/4 NPTF

Part No.	Side View With Extended And Compressed Height	Upper Mounting View	Lower Mounting View	Manufacturer Numbers
2B12-345 Flexmember 578-92-3-315		ASA-92-8-005 	ASA-92-6-002 	Conti FD331-26514 FIRESTONE 7545 HENDRICKSON 1796 TRIANGLE 4514 WATSON & CHALIN AS-0087-1F
2B12-346 Flexmember 578-92-3-315		ASA-92-8-005 	ASA-92-6-002 	Conti FD331-26541 FIRESTONE 7550 HITEER 10315 TRIANGLE 4541 WATSON & CHALIN AS-0087
2B12-402 Flexmember 578-92-3-310		ASA-92-8-005 	ASA-92-6-002 	Conti FD330-30370 DAYTON 354-7446 FIRESTONE 7446 HDA PMABG-7446B HENDRICKSON 4370 B-3798 INT'L/ NAVISTAR 554791C1 LOAD GUARD SC2027 R & S TRUCK & BODY 1082914 SILENT DRIVE AS-7446 TRIANGLE 4370 WATSON & CHALIN AS-0005
2B12-406 Flexmember 578-92-3-309		ASA-92-8-005 	ASA-92-6-002 	Conti FD330-22331 DAYTON 354-7410 FIRESTONE 7410 FREIGHTLINER 16-11378-000 INT'L/ NAVISTAR 554792C1 LOAD GUARD SC2023 TAURUS AS214-7410 TRIANGLE 4331
2B12-410 Flexmember 578-92-3-309		ASA-92-8-017 	ASA-92-6-004 	Conti FD330-22346 DAYTON 354-7404 FIRESTONE 7404 HENDRICKSON B-1345 B-5468 INT'L/ NAVISTAR 554793C1 LOAD GUARD SC2022 TAURUS AS214-7404 TRIANGLE 4346

- - Bolt or Stud 1/2-13 or 1/2-20
- ⊗ - Air Fitting - 1/4 NPTF
- - Stud - 3/4-10
- ◐ - Tapped Hole on Top Retainers 3/8-16, on Pistons - 1/2-13
- ⊗ - Air Fitting - 1/2 NPTF or 3/8 NPTF
- ⊗ - Combination Stud Air Fitting Stud - 3/4-16; Air Fitting - 1/4 NPTF

AIRSPRING BELLOWS

Part No.	Side View With Extended And Compressed Height	Upper Mounting View	Lower Mounting View	Manufacturer Numbers
2B12-411 Flexmember 578-92-3-309		ASA-92-8-088 	ASA-92-6-006 	Conti FD330-22472 DAYTON 354-7181 FIRESTONE 7181 FRUEHAUF UAB-5620 UCC-3054-1 INT'L/ NAVISTAR 554794C1 LOAD GUARD SC2018 TAURUS AS214-7181 TRIANGLE 4472
2B12-412 Flexmember 578-92-3-309		ASA-92-8-088 	ASA-92-6-038 	Conti FD330-22471 DAYTON 354-7183 FIRESTONE 7183 FRUEHAUF UCA-0112 UCA-0112B INT'L/ NAVISTAR 554795C1 LOAD GUARD SC2019 TAURUS AS214-7183 TRIANGLE 4471
2B12-416 Flexmember 578-92-3-315		ASA-92-8-002 	ASA-92-6-002 	Conti FD330-30369 FIRESTONE 7444 HENDRICKSON B-9830 TRIANGLE 4369
2B12-424 Flexmember 578-92-3-309		ASA-92-8-006 	ASA-92-6-002 	TRAILERS DE MONTERREY 73312A
2B12-425 Flexmember 578-92-3-309		ASA-92-8-002 	ASA-92-6-002 	Conti FD330-22363 E-Z RIDE 8030190 FIRESTONE 7180 INT'L/ NAVISTAR 1685179C1 LOAD GUARD SC2075 NEWAY 570-07-180 PEERLESS 0550-00001 RIDEWELL 1003587180C S-4538-C TAURUS AS214-7180 TRIANGLE 4363

- Bolt or Stud 1/2-13 or 1/2-20
- Air Fitting - 1/4 NPTF
- Stud - 3/4-10
- Tapped Hole on Top Retainers 3/8-16, on Pistons - 1/2-13
- Air Fitting - 1/2 NPTF or 3/8 NPTF
- Combination Stud Air Fitting Stud - 3/4-16; Air Fitting - 1/4 NPTF

Part No.	Side View With Extended And Compressed Height	Upper Mounting View	Lower Mounting View	Manufacturer Numbers	
2B12-426 Flexmember 578-92-3-309		ASA-92-8-003 	ASA-92-6-002 	Conti FD330-22365 DAYTON 354-7406 FIRESTONE 7406 INT'L/ NAVISTAR 1685180C1 LOAD GUARD SC2076 RIDEWELL 1003587406C S-3159-C	TAURUS AS214-7406 TRIANGLE 4365
2B12-427 Flexmember 578-92-3-309		ASA-92-8-004 	ASA-92-6-002 	Conti FD330-22343 DAYTON 354-7429 FIRESTONE 7429 INT'L/ NAVISTAR 1685181C1 KWIK-LOK / TODCO CP-5223 LOAD GUARD SC2077	TAURUS AS214-7429 TRIANGLE 4343
2B12-428 Flexmember 578-92-3-310		ASA-92-8-002 	ASA-92-6-002 	Conti FD330-30372 FIRESTONE 7473 INT'L/ NAVISTAR 1685182C1 LOAD GUARD SC2078 RIDEWELL 1003587473C TRIANGLE 4372	
2B12-429 Flexmember 578-92-3-309		ASA-92-8-006 750-14 NPTF 	ASA-92-6-002 	Conti FD330-22780 FIRESTONE 7184	
2B12-432 Flexmember 578-92-3-309		ASA-92-8-005 	ASA-92-6-001 	Conti FD330-22368 FD330-22465 FIRESTONE 7423 INT'L/ NAVISTAR 1681750C1 LOAD GUARD SC2101 TRIANGLE 4368 4465	

- Bolt or Stud 1/2-13 or 1/2-20
- Air Fitting - 1/4 NPTF
- Stud - 3/4-10
- Tapped Hole on Top Retainers 3/8-16, on Pistons - 1/2-13
- Air Fitting - 1/2 NPTF or 3/8 NPTF
- Combination Stud Air Fitting Stud - 3/4-16; Air Fitting - 1/4 NPTF

AIRSPRING BELLOWS

Part No.	Side View With Extended And Compressed Height	Upper Mounting View	Lower Mounting View	Manufacturer Numbers
2B12-434 Flexmember 578-92-3-310		ASA-92-8-017 	ASA-92-6-002 	Conti FD330-30371 FD330-30464 FIRESTONE 7472 HENDRICKSON 36514-5 B-12514-005 INT'L / NAVISTAR 1681751C1 LOAD GUARD SC2128 SAUR AXLES (SAS) PB10-784 TRIANGLE 4371 4464
2B12-440 Flexmember 578-92-3-315		ASA-92-8-005 	ASA-92-6-004 	Conti FD331-26480 FIRESTONE 7555 REYCO 18813-01 20018-01 TRIANGLE 4480
2B12-446 Flexmember 578-92-3-310		ASA-92-8-002 	ASA-92-6-002 	Conti FD330-30369 FIRESTONE 7444 HENDRICKSON B-9830 TRIANGLE 4369
2B12-463 Flexmember 578-92-3-309		ASA-92-8-257 	ASA-92-6-002 	Conti FD330-22540 FIRESTONE 6850 RIDEWELL 1003586850C
2B14-354 Flexmember 578-92-3-353		ASA-92-8-028 	ASA-92-6-013 	Conti FD530-22374 DAYTON 354-7145 FIRESTONE 7145 INT'L / NAVISTAR 554796C1 LOAD GUARD SC2016 MACK TRUCK 57QL239 RIDEWELL 1003587145C S-4540-C TRIANGLE 4374 VOLVO 35203-0005 35203-3204

- - Bolt or Stud 1/2-13 or 1/2-20
- ⊗ - Air Fitting - 1/4 NPTF
- ⊙ - Stud - 3/4-10
- ⊕ - Tapped Hole on Top Retainers 3/8-16, on Pistons - 1/2-13
- ⊗ - Air Fitting - 1/2 NPTF or 3/8 NPTF
- ⊗ - Combination Stud Air Fitting Stud - 3/4-16; Air Fitting - 1/4 NPTF

Part No.	Side View With Extended And Compressed Height	Upper Mounting View	Lower Mounting View	Manufacturer Numbers
2B14-355 Flexmember 578-92-3-353		ASA-92-8-028 	ASA-92-6-013 	AMERICAN CARRIER 8003-005 Conti FD530-22342 DAYTON 354-7146 FIRESTONE 7146 INT'L / NAVISTAR 554797C1 LOAD GUARD SC2017 NEWAY 905-57-039 AR-1520 RIDEWELL 1003587146C TRIANGLE 4342
2B14-356 Flexmember 578-92-3-353		ASA-92-8-028 	ASA-92-6-013 	Conti FD530-22321 DAYTON 354-7136 FIRESTONE 7136 GRANNING 1626 HDA PMABG-7136B HENDRICKSON B-1080 INT'L / NAVISTAR 554798C1 LOAD GUARD SC2014 R & S TRUCK & BODY 1027556 RIDEWELL 1003587136C TRIANGLE 4321 WATSON & CHALIN AS-0004
2B14-359 Flexmember 578-92-3-353		ASA-92-8-031 	ASA-92-6-015 	Conti FD530-22316 DAYTON 354-7140 FIRESTONE 7140 GRANNING 1015 HDA PMABG-7140B HENDRICKSON B-3184 INT'L / NAVISTAR 554799C1 LOAD GUARD SC2015 R & S TRUCK & BODY 1090214 RIDEWELL 1003587140C TRIANGLE 4316 WATSON & CHALIN AS-0008
2B14-360 Flexmember 578-92-3-353		ASA-92-8-031 	ASA-92-6-015 	Conti FD530-22311 DAYTON 354-7135 FIRESTONE 7135 HENDRICKSON B-12514-014 INT'L / NAVISTAR 554800C1 LOAD GUARD SC2013 NEWAY 905-57-001 PEZZANI AR-21-A RIDEWELL 1003587135C S-1326-C TRIANGLE 4311 TRUCKSTELL 63641 63644
2B14-363 Flexmember 578-92-3-356		ASA-92-8-030 	ASA-92-6-013 	

- - Bolt or Stud 1/2-13 or 1/2-20
- ⊗ - Air Fitting - 1/4 NPTF
- - Stud - 3/4-10
- ⊙ - Tapped Hole on Top Retainers 3/8-16, on Pistons - 1/2-13
- ⊗ - Air Fitting - 1/2 NPTF or 3/8 NPTF
- ⊙ - Combination Stud Air Fitting Stud - 3/4-16; Air Fitting - 1/4 NPTF

AIRSPRING BELLOWS

Part No.	Side View With Extended And Compressed Height	Upper Mounting View	Lower Mounting View	Manufacturer Numbers
2B14-365 Flexmember 578-92-3-356		ASA-92-8-046 	ASA-92-6-014 	Conti FD530-30451 DAYTON 354-6801 E-Z RIDE 8030160 FIRESTONE 6801 HENDRICKSON B-2734 INT'L / NAVISTAR 1685183C1 LOAD GUARD SC2079 RIDEWELL 1003586801C TRIANGLE 4451 WATSON & CHALIN AS-0021
2B14-366 Flexmember 578-92-3-353		ASA-92-8-100 	ASA-92-6-015 	Conti FD530-30449 DAYTON 354-6803 FIRESTONE 6803 HENDRICKSON B-6412 LOAD GUARD SC2129 TRIANGLE 4449
2B14-367 Flexmember 578-92-3-353		ASA-92-8-049 	ASA-92-6-043 	Conti FD530-22345 DAYTON 354-7123 FIRESTONE 7123 7133 INT'L / NAVISTAR 1685184C1 KWIK-LOK / TODCO 53671 LOAD GUARD SC2080 TRIANGLE 4345
2B14-383 Flexmember 578-92-3-356		ASA-92-8-174 	ASA-92-6-118 	Conti FD530-35530 FIRESTONE 7557 HISTEER 10316 REYCO 19983-01 TRIANGLE 4530 WATSON & CHALIN AS-0089
2B14-462 Flexmember 578-92-3-356		ASA-92-8-030 	ASA-92-6-013 	Conti FD530-30532 FD530-35720 FIRESTONE 6805 RIDEWELL 1003586805C

- Bolt or Stud 1/2-13 or 1/2-20
- Air Fitting - 1/4 NPTF
- Stud - 3/4-10
- Tapped Hole on Top Retainers 3/8-16, on Pistons - 1/2-13
- Air Fitting - 1/2 NPTF or 3/8 NPTF
- Combination Stud Air Fitting Stud - 3/4-16; Air Fitting - 1/4 NPTF

Part No.	Side View With Extended And Compressed Height	Upper Mounting View	Lower Mounting View	Manufacturer Numbers
2B14-469 Flexmember 566-23-8-329		ASA-92-8-352 	ASA-92-6-016 	NEWAY 905-57-257
2B14-470 Flexmember 578-92-3-356		ASA-92-8-031 	ASA-92-6-015 	Conti FD530-35544 FIRESTONE 7782 TRIANGLE 4544 WATSON & CHALIN AS-0032
2B14-473 Flexmember 578-92-3-353		ASA-92-8-046 	ASA-92-6-014 	
2B14-476 Flexmember 578-92-3-356		ASA-92-8-352 	ASA-92-6-016 	Conti FD530-35543 FIRESTONE 6799 NEWAY 905-57-203 WATSON & CHALIN AS-0034
2B14-479 Flexmember 578-923-356		ASA-92-8-030 	ASA-92-6-013 	

- Bolt or Stud 1/2-13 or 1/2-20
- Air Fitting - 1/4 NPTF
- Combination Stud Air Fitting
Stud - 3/4-16; Air Fitting - 1/4 NPTF
- Tapped Hole on Top Retainers
3/8-16, on Pistons - 1/2-13
- Air Fitting - 1/2 NPTF or
3/8 NPTF
- Stud - 3/4-10

AIRSPRING BELLOWS

Part No.	Side View With Extended And Compressed Height	Upper Mounting View	Lower Mounting View	Manufacturer Numbers
2B6-530 Flexmember 579-923-510		ASC-92-8-154 	ASB-92-6-051 	
2B6-535 Flexmember 579-923-515		ASC-92-8-175 	ASA-92-6-052 	Conti FD110-15766 LOADAIR P10-754U
2B7-542 Flexmember 579-923-525		ASC-92-8-171 	ASB-92-6-058 	
2B7-548 Flexmember 579-923-526		ASC-92-8-171 	ASC-92-6-122 	HENDRICKSON 5079
2B8-550 Flexmember 579-923-530		ASA-92-8-114 	ASB-92-6-049 	AMERICAN CARRIER 8003-006 Conti FD120-20509 FIRESTONE 7325 MACK TRUCK 227QS32 57QK1113 TRIANGLE 4509 WATSON & CHALIN AS-0030

- - Bolt or Stud 1/2-13 or 1/2-20
- ⊗ - Air Fitting - 1/4 NPTF
- - Stud - 3/4-10
- ⊙ - Tapped Hole on Top Retainers 3/8-16, on Pistons - 1/2-13
- ⊗ - Air Fitting - 1/2 NPTF or 3/8 NPTF
- ⊗ - Combination Stud Air Fitting Stud - 3/4-16; Air Fitting - 1/4 NPTF

Part No.	Side View With Extended And Compressed Height	Upper Mounting View	Lower Mounting View	Manufacturer Numbers																				
2B9-200 Flexmember 579-92-3-202		ASA-92-8-016 	ASA-92-6-010 	<table border="0"> <tr> <td>Conti FD200-19320</td> <td>LOAD GUARD SC2011</td> </tr> <tr> <td>DAYTON 354-6910</td> <td>MASA 227138412</td> </tr> <tr> <td>DINA A-8127-19</td> <td>PREVOST 63-0173</td> </tr> <tr> <td>FIRESTONE 6910</td> <td>R & S TRUCK & BODY</td> </tr> <tr> <td>GRANNING 1371</td> <td>1027405 RIDEWELL</td> </tr> <tr> <td>HDA PMABG-6910B</td> <td>1003586910C S-4512-C</td> </tr> <tr> <td>HENDRICKSON 45843-3</td> <td>TAURUS AS218-6910</td> </tr> <tr> <td>B-8768</td> <td>TRIANGLE 4320</td> </tr> <tr> <td>INT'L/ NAVISTAR</td> <td>WATSON & CHALIN</td> </tr> <tr> <td>554783C1</td> <td>AS-0001</td> </tr> </table>	Conti FD200-19320	LOAD GUARD SC2011	DAYTON 354-6910	MASA 227138412	DINA A-8127-19	PREVOST 63-0173	FIRESTONE 6910	R & S TRUCK & BODY	GRANNING 1371	1027405 RIDEWELL	HDA PMABG-6910B	1003586910C S-4512-C	HENDRICKSON 45843-3	TAURUS AS218-6910	B-8768	TRIANGLE 4320	INT'L/ NAVISTAR	WATSON & CHALIN	554783C1	AS-0001
Conti FD200-19320	LOAD GUARD SC2011																							
DAYTON 354-6910	MASA 227138412																							
DINA A-8127-19	PREVOST 63-0173																							
FIRESTONE 6910	R & S TRUCK & BODY																							
GRANNING 1371	1027405 RIDEWELL																							
HDA PMABG-6910B	1003586910C S-4512-C																							
HENDRICKSON 45843-3	TAURUS AS218-6910																							
B-8768	TRIANGLE 4320																							
INT'L/ NAVISTAR	WATSON & CHALIN																							
554783C1	AS-0001																							
2B9-201 Flexmember 579-92-3-202		ASA-92-8-016 	ASA-92-6-010 	<table border="0"> <tr> <td>Conti FD200-19499</td> <td>MASA 227004001</td> </tr> <tr> <td>DAYTON 354-6902</td> <td>R & S TRUCK & BODY</td> </tr> <tr> <td>FIRESTONE 6935</td> <td>1027505 RIDEWELL</td> </tr> <tr> <td>GRANNING 4848</td> <td>S-1728-C SAUR AXLES (SAS)</td> </tr> <tr> <td>HDA PMABG-6902B</td> <td>P50-733A (LIFT SUSPENSIONS INC.</td> </tr> <tr> <td>HENDRICKSON B-2630</td> <td>200042 TAURUS</td> </tr> <tr> <td>INT'L/ NAVISTAR</td> <td>AS218-6902 TRIANGLE</td> </tr> <tr> <td>554784C1</td> <td>4310 4499</td> </tr> <tr> <td>LOAD GUARD SC2010</td> <td></td> </tr> </table>	Conti FD200-19499	MASA 227004001	DAYTON 354-6902	R & S TRUCK & BODY	FIRESTONE 6935	1027505 RIDEWELL	GRANNING 4848	S-1728-C SAUR AXLES (SAS)	HDA PMABG-6902B	P50-733A (LIFT SUSPENSIONS INC.	HENDRICKSON B-2630	200042 TAURUS	INT'L/ NAVISTAR	AS218-6902 TRIANGLE	554784C1	4310 4499	LOAD GUARD SC2010			
Conti FD200-19499	MASA 227004001																							
DAYTON 354-6902	R & S TRUCK & BODY																							
FIRESTONE 6935	1027505 RIDEWELL																							
GRANNING 4848	S-1728-C SAUR AXLES (SAS)																							
HDA PMABG-6902B	P50-733A (LIFT SUSPENSIONS INC.																							
HENDRICKSON B-2630	200042 TAURUS																							
INT'L/ NAVISTAR	AS218-6902 TRIANGLE																							
554784C1	4310 4499																							
LOAD GUARD SC2010																								
2B9-206 Flexmember 579-92-3-202		ASA-92-8-040 	ASA-92-6-010 	<table border="0"> <tr> <td>Conti FD200-19315</td> <td>NAVISTAR 1685175C1</td> </tr> <tr> <td>DAYTON 354-6905</td> <td>LOAD GUARD SC2071</td> </tr> <tr> <td>E-Z RIDE 8030120</td> <td>RIDEWELL 1003586905C</td> </tr> <tr> <td>FIRESTONE 6905</td> <td>S-2845-C TAURUS</td> </tr> <tr> <td>HENDRICKSON 45843-1</td> <td>AS218-6905 TRIANGLE</td> </tr> <tr> <td>B-3518</td> <td>4315 WATSON & CHALIN</td> </tr> <tr> <td>B-5270</td> <td>AS-0020</td> </tr> <tr> <td>INT'L/</td> <td></td> </tr> </table>	Conti FD200-19315	NAVISTAR 1685175C1	DAYTON 354-6905	LOAD GUARD SC2071	E-Z RIDE 8030120	RIDEWELL 1003586905C	FIRESTONE 6905	S-2845-C TAURUS	HENDRICKSON 45843-1	AS218-6905 TRIANGLE	B-3518	4315 WATSON & CHALIN	B-5270	AS-0020	INT'L/					
Conti FD200-19315	NAVISTAR 1685175C1																							
DAYTON 354-6905	LOAD GUARD SC2071																							
E-Z RIDE 8030120	RIDEWELL 1003586905C																							
FIRESTONE 6905	S-2845-C TAURUS																							
HENDRICKSON 45843-1	AS218-6905 TRIANGLE																							
B-3518	4315 WATSON & CHALIN																							
B-5270	AS-0020																							
INT'L/																								
2B9-210 Flexmember 579-92-3-202		ASA-92-8-040 	ASA-92-6-010 	<table border="0"> <tr> <td>Conti FD200-19362</td> <td></td> </tr> <tr> <td>FIRESTONE 6908</td> <td></td> </tr> <tr> <td>TRIANGLE 4362</td> <td></td> </tr> <tr> <td>WATSON & CHALIN</td> <td></td> </tr> <tr> <td>AS-0035</td> <td></td> </tr> </table>	Conti FD200-19362		FIRESTONE 6908		TRIANGLE 4362		WATSON & CHALIN		AS-0035											
Conti FD200-19362																								
FIRESTONE 6908																								
TRIANGLE 4362																								
WATSON & CHALIN																								
AS-0035																								

- - Bolt or Stud 1/2-13 or 1/2-20
- ⊗ - Air Fitting - 1/4 NPTF
- - Stud - 3/4-10
- ⊙ - Tapped Hole on Top Retainers 3/8-16, on Pistons - 1/2-13
- ⊗ - Air Fitting - 1/2 NPTF or 3/8 NPTF
- ⊗ - Combination Stud Air Fitting Stud - 3/4-16; Air Fitting - 1/4 NPTF

AIRSPRING BELLOWS

Part No.	Side View With Extended And Compressed Height	Upper Mounting View	Lower Mounting View	Manufacturer Numbers
2B9-216 Flexmember 579-92-3-202		ASA-92-8-060 .750-14 NPTF 	ASA-92-6-010 	DINA AZ-8127-19 PREVOST 63-0174 TRAILERS DE MONTERREY 73312B
2B9-218 Flexmember 578-92-3-206		ASA-92-8-113 	ASA-92-6-010 	Conti FD200-25453 FIRESTONE 6927 INT'L/ NAVISTAR 1685176C1 LOAD GUARD SC2072 REYCO 12906-01 12906-02 TAURUS AS218-6927 TRIANGLE 4453
2B9-225 Flexmember 578-92-3-202		ASA-92-8-117 500-14 NPTF (DRYSEAL) 	ASA-92-6-044 	FIRESTONE 6928 ITX 1999408
2B9-229 Flexmember 578-92-3-211		ASA-92-8-113 	ASA-92-6-077 	Conti FD200-19505 FD200-22706 FIRESTONE 6897 TRIANGLE 4505 WATSON & CHALIN AS-0058
2B9-230 Flexmember 578-92-3-202		ASA-92-8-113 	ASA-92-6-044 	Conti FD200-19450 FIRESTONE 6940 TRIANGLE 4450

- - Bolt or Stud 1/2-13 or 1/2-20
- ⊗ - Air Fitting - 1/4 NPTF
- - Stud - 3/4-10
- ⊙ - Tapped Hole on Top Retainers 3/8-16, on Pistons - 1/2-13
- ⊗ - Air Fitting - 1/2 NPTF or 3/8 NPTF
- ⊗ - Combination Stud Air Fitting Stud - 3/4-16; Air Fitting - 1/4 NPTF

Part No.	Side View With Extended And Compressed Height	Upper Mounting View	Lower Mounting View	Manufacturer Numbers
2B9-239 Flexmember 578-92-3-211		ASA-92-8-016 	ASA-92-6-010 	Conti FD200-19310 FIRESTONE 6902 RIDEWELL 1003586902C WATSON & CHALIN AS-0002
2B9-240 Flexmember 578-92-3-202		ASB-92-9-151 	ASB-92-9-151 	FIRESTONE 7119 MCI 12C-1-36 PREVOST 63-0166
2B9-244 Flexmember 578-92-3-202		ASA-92-8-172 	ASA-92-6-044 	
2B9-245 Flexmember 578-92-3-202		ASA-92-8-113 	ASA-92-6-108 	Conti FD200-19510 FIRESTONE 7788 TRIANGLE 4510 WATSON & CHALIN AS-0088
2B9-246 Flexmember 578-92-3-211		ASA-92-8-172 	ASA-92-6-108 	Conti FD200-19452 FIRESTONE 6932 RIDEWELL 1003586932C TRIANGLE 4452

- - Bolt or Stud 1/2-13 or 1/2-20
- ⊗ - Air Fitting - 1/4 NPTF
- - Stud - 3/4-10
- ⊙ - Tapped Hole on Top Retainers 3/8-16, on Pistons - 1/2-13
- ⊗ - Air Fitting - 1/2 NPTF or 3/8 NPTF
- ⊗ - Combination Stud Air Fitting Stud - 3/4-16; Air Fitting - 1/4 NPTF

AIRSPRING BELLOWS

Part No.	Side View With Extended And Compressed Height	Upper Mounting View	Lower Mounting View	Manufacturer Numbers
2B9-250 Flexmember 578-92-3-206		ASA-92-8-040 	ASA-92-6-010 	Conti FD200-25426 FIRESTONE 6943 LOAD GUARD SC2122 NEWAY 905-57-237 SUSPENSIONS INC. 200835 TRIANGLE 4426 WATSON & CHALIN AS-0041
2B9-251 Flexmember 578-92-3-206		ASA-92-8-040 	ASA-92-6-010 	Conti FD200-25429 FIRESTONE 6948 LOAD GUARD SC2123 RIDEWELL 1003586948C TRIANGLE 4429
2B9-252 Flexmember 578-92-3-206		ASA-92-8-172 	ASA-92-6-044 	Conti FD200-19448 FIRESTONE 6944 HISTEER 10302 LOAD GUARD SC2124 SUSPENSIONS INC. 200118 TRIANGLE 4448
2B9-253 Flexmember 578-92-3-206		ASA-92-8-040 	ASA-92-6-010 	Conti FD200-25427 FIRESTONE 6945 LOAD GUARD SC2125 RIDEWELL 1003586945C TRIANGLE 4427
2B9-254 Flexmember 578-92-3-206		ASA-92-8-172 	ASA-92-6-010 	Conti FD200-25463 FIRESTONE 6946 LOAD GUARD SC2126 RIDEWELL 1003586946C SUSPENSIONS INC. 200180 TRIANGLE 4463

- - Bolt or Stud 1/2-13 or 1/2-20
- ⊗ - Air Fitting - 1/4 NPTF
- - Stud - 3/4-10
- ⊕ - Tapped Hole on Top Retainers 3/8-16, on Pistons - 1/2-13
- ⊗ - Air Fitting - 1/2 NPTF or 3/8 NPTF
- ⊗ - Combination Stud Air Fitting Stud - 3/4-16; Air Fitting - 1/4 NPTF

Part No.	Side View With Extended And Compressed Height	Upper Mounting View	Lower Mounting View	Manufacturer Numbers
2B9-255 Flexmember 578-92-3-206		ASA-92-8-016 	ASA-92-6-010 	Conti FD200-25428 DAYTON 354-6947 FIRESTONE 6947 HENDRICKSON B-8701 LOAD GUARD SC2127 RIDEWELL 1003586947C TRIANGLE 4428
2B9-265 Flexmember 578-92-3-206		ASA-92-8-270 	ASA-92-6-044 	Conti FD200-19448
2B9-266 Flexmember 578-92-3-208		ASA-92-8-292 	ASA-92-6-044 	Conti FD200-25454 HISTEER 10307 TRIANGLE 4454
2B9-270 Flexmember 578-92-3-206		ASA-92-8-298 	ASA-92-6-010 	RIDEWELL 1002B09270G
2B9-280 Flexmember 578-92-3-211		ASA-92-8-172 	ASA-92-6-044 	Conti FD200-19448 FIRESTONE 6941 HISTEER 10302 TRIANGLE 4448

- - Bolt or Stud 1/2-13 or 1/2-20
- ⊗ - Air Fitting - 1/4 NPTF
- - Stud - 3/4-10
- ⊙ - Tapped Hole on Top Retainers 3/8-16, on Pistons - 1/2-13
- ⊗ - Air Fitting - 1/2 NPTF or 3/8 NPTF
- ⊗ - Combination Stud Air Fitting Stud - 3/4-16; Air Fitting - 1/4 NPTF

AIRSPRING BELLOWS

Part No.	Side View With Extended And Compressed Height	Upper Mounting View	Lower Mounting View	Manufacturer Numbers
2B9-288 Flexmember 578-92-3-211		ASA-92-8-016 	ASA-92-6-010 	Conti FD200-19504 FIRESTONE 6926
2B9-296 Flexmember 578-923-211		ASA-92-8-113 	ASA-92-6-125 	
2B9-606 Flexmember 578-923-211		ASA-92-8-040 	ASA-92-6-010 	
2B9-607 Flexmember 578-923-208		ASA-92-8-270 	ASA-92-6-010 	
2B9-611 Flexmember 578-923-211		ASA-92-8-270 	ASA-92-6-134 	

- - Bolt or Stud 1/2-13 or 1/2-20
- ⊗ - Air Fitting - 1/4 NPTF
- - Stud - 3/4-10
- ⊗ (with dot) - Tapped Hole on Top Retainers 3/8-16, on Pistons - 1/2-13
- ⊗ (with cross) - Air Fitting - 1/2 NPTF or 3/8 NPTF
- ⊗ (with circle) - Combination Stud Air Fitting Stud - 3/4-16; Air Fitting - 1/4 NPTF

Part No.	Side View With Extended And Compressed Height	Upper Mounting View	Lower Mounting View	Manufacturer Numbers
2B9-614 Flexmember 578-9-23-211		ASA-92-8-270 	ASA-92-6-134 	
3B12-300 Flexmember 578-93-3-100		ASA-92-8-017 	ASA-92-6-002 	Conti FT330-29431 FT330-29469 DAYTON 354-8008 FIRESTONE 8008 8025 HENDRICKSON B-11637 LOAD GUARD SC2130 RIDEWELL 1003588008C TRIANGLE 4431 4469 WATSON & CHALIN AS-0019
3B12-301 Flexmember 578-93-3-100		ASA-92-8-002 	ASA-92-6-002 	Conti FT330-29432 FT330-29498 FIRESTONE 8010 8030 LOAD GUARD SC2119 RIDEWELL 1003588010C 1003588030C S-5844-C TRIANGLE 4432
3B12-303 Flexmember 578-93-3-100		ASA-92-8-005 	ASA-92-6-002 	Conti FT330-29434 FIRESTONE 8018 HITEER 10303 LOAD GUARD SC2131 TRIANGLE 4434 WATSON & CHALIN AS-0075
3B12-304 Flexmember 578-93-3-100		ASA-92-8-002 	ASA-92-6-000 	Conti FT330-29503 FIRESTONE 8006 LOAD GUARD SC2132 SUSPENSIONS INC. 200620 TRIANGLE 4430 4503

- - Bolt or Stud 1/2-13 or 1/2-20
- ⊗ - Air Fitting - 1/4 NPTF
- - Stud - 3/4-10
- ⊙ - Tapped Hole on Top Retainers 3/8-16, on Pistons - 1/2-13
- ⊗ - Air Fitting - 1/2 NPTF or 3/8 NPTF
- ⊙ - Combination Stud Air Fitting Stud - 3/4-16; Air Fitting - 1/4 NPTF

AIRSPRING BELLOWS

Part No.	Side View With Extended And Compressed Height	Upper Mounting View	Lower Mounting View	Manufacturer Numbers
3B12-305 Flexmember 578-93-3-100		ASA-92-8-006 .750-14 NPTF 	ASA-92-6-002 	
3B12-310 Flexmember 578-93-3-100		ASA-92-8-005 	ASA-92-6-002 	Conti FT330-29466 FIRESTONE 8027 SILENT DRIVE AS-8025 AS-8027 SUSPENSIONS INC. 200117 TRIANGLE 4466
3B12-312 Flexmember 578-93-3-100		ASA-92-8-005 	ASA-92-6-035 	Conti FT330-29508 FT330-29525 FIRESTONE 8033 HENDRICKSON B-14487 LOAD GUARD SC2784 TRIANGLE 4508 4525
3B12-315 Flexmember 578-93-3-100		ASA-92-8-017 	ASA-92-6-111 	Conti FT330-29547
3B12-319 Flexmember 578-93-3-100		ASA-92-8-017 	ASA-92-6-002 	Conti FT330-29413 FIRESTONE 8032 HENDRICKSON B-12405 S-12405 TRIANGLE 4413 WATSON & CHALIN AS-0048

- - Bolt or Stud 1/2-13 or 1/2-20
- ⊗ - Air Fitting - 1/4 NPTF
- - Stud - 3/4-10
- ⊙ - Tapped Hole on Top Retainers 3/8-16, on Pistons - 1/2-13
- ⊗ - Air Fitting - 1/2 NPTF or 3/8 NPTF
- ⊗ - Combination Stud Air Fitting Stud - 3/4-16; Air Fitting - 1/4 NPTF

Part No.	Side View With Extended And Compressed Height	Upper Mounting View	Lower Mounting View	Manufacturer Numbers
3B12-322 Flexmember 578-93-3-103		ASA-92-8-230 	ASA-92-6-110 	FIRESTONE 8042 HENDRICKSON 1015 NEWAY 905-57-236
3B12-323 Flexmember 578-93-3-103		ASA-92-8-367 	ASA-92-6-110 	FIRESTONE 8043 HENDRICKSON S-14795
3B12-324 Flexmember 578-93-3-100		ASA-92-8-159 	ASA-92-6-002 	WATSON & CHALIN AS-0048-2G
3B12-325 Flexmember 578-93-3-103		ASA-92-8-363 	ASA-92-6-106 	FIRESTONE 8048
3B12-326 Flexmember 578-93-3-103		ASA-92-8-364 	ASA-92-6-106 	FIRESTONE 8047

- - Bolt or Stud 1/2-13 or 1/2-20
- ⊗ - Air Fitting - 1/4 NPTF
- - Stud - 3/4-10
- ◐ - Tapped Hole on Top Retainers 3/8-16, on Pistons - 1/2-13
- ⊗ - Air Fitting - 1/2 NPTF or 3/8 NPTF
- ⊗ - Combination Stud Air Fitting Stud - 3/4-16; Air Fitting - 1/4 NPTF

AIRSPRING BELLOWS

Part No.	Side View With Extended And Compressed Height	Upper Mounting View	Lower Mounting View	Manufacturer Numbers
3B12-328 Flexmember 578-93-3-100		ASA-92-8-017 	ASA-92-6-111 	Conti FT330-29546 FIRESTONE 7994 TRIANGLE 4546 WATSON & CHALIN AS-0019-1F
3B12-329 Flexmember 578-93-3-100		ASA-92-8-159 	ASA-92-6-111 	Conti FT330-29547 FIRESTONE 7990 7995 TRIANGLE 4547 WATSON & CHALIN AS-0048-1F
3B12-335 Flexmember 578-93-3-100		ASA-92-8-005 	ASA-92-6-111 	Conti FT330-29520 FT330-29723 FIRESTONE 7996 W013587996 GRANNING 8221 TRIANGLE 4520
3B12-338 Flexmember 578-93-3-100		ASA-92-8-331 	ASA-92-6-002 	
3B12-342 Flexmember 578-93-3-100		ASA-92-8-431 	ASA-92-6-002 	WATSON & CHALIN AS-0048-3G

- - Bolt or Stud 1/2-13 or 1/2-20
- ⊗ - Air Fitting - 1/4 NPTF
- - Stud - 3/4-10
- ◐ - Tapped Hole on Top Retainers 3/8-16, on Pistons - 1/2-13
- ⊗ - Air Fitting - 1/2 NPTF or 3/8 NPTF
- ⊗ - Combination Stud Air Fitting Stud - 3/4-16; Air Fitting - 1/4 NPTF

Part No.	Side View With Extended And Compressed Height	Upper Mounting View	Lower Mounting View	Manufacturer Numbers
3B12-347 Flexmember 578-93-3-103		ASA-92-8-367 	ASA-92-6-121 	
3B12-415 Flexmember 578-93-3-105		ASA-92-8-017 	ASA-92-6-002 	FIRESTONE 8038 HISTEER 10313
3B12-416 Flexmember 578-93-3-105		ASA-92-8-005 	ASA-92-6-002 	FIRESTONE 8039 HISTEER 10303
3B14-351 Flexmember 578-93-3-350		ASA-92-8-028 	ASA-92-6-013 	
3B14-354 Flexmember 578-93-3-350		ASA-92-8-028 	ASA-92-6-013 	Conti FT530-32336 E-Z RIDE 8030170 FIRESTONE 7808 INT'L/ NAVISTAR 554801C1 LOAD GUARD SC2031 PEERLESS 0550-00030 RIDEWELL 1003587808C S-4830-C TRIANGLE 4336 TRUCKSTELL 63640

- - Bolt or Stud 1/2-13 or 1/2-20
- ⊗ - Air Fitting - 1/4 NPTF
- - Stud - 3/4-10
- ◐ - Tapped Hole on Top Retainers 3/8-16, on Pistons - 1/2-13
- ⊗ - Air Fitting - 1/2 NPTF or 3/8 NPTF
- ⊗ - Combination Stud Air Fitting Stud - 3/4-16; Air Fitting - 1/4 NPTF

AIRSPRING BELLOWS

Part No.	Side View With Extended And Compressed Height	Upper Mounting View	Lower Mounting View	Manufacturer Numbers
3B14-356 Flexmember 578-93-3-350		ASA-92-8-028 	ASA-92-6-013 	Conti FT530-32329 DAYTON 354-7798 FIRESTONE 7798 GRANNING 1613 HDA PMABG-7798B INT'L/ NAVISTAR 554802C1 LOAD GUARD SC2029 TRIANGLE 4329 4436 WATSON & CHALIN AS-0006
3B14-359 Flexmember 578-93-3-350		ASA-92-8-031 	ASA-92-6-015 	Conti FT530-32325 DAYTON 354-7818 E-Z RIDE 8030180 FIRESTONE 7816 7818 GRANNING 1014 1476 HENDRICKSON B-6861 AS-0033 NAVISTAR 554803C1 LOAD GUARD SC2032 RIDEWELL 1003587818C 1003587839C S-2685-C TRIANGLE 4325 4437 WATSON & CHALIN AS-0025
3B14-360 Flexmember 578-93-3-350		ASA-92-8-031 	ASA-92-6-015 	Conti FT530-32333 DAYTON 354-7800 FIRESTONE 7800 GRANNING 4514 HOLLAND HITCH 4514 INT'L/ NAVISTAR 554804C1 LOAD GUARD SC2030 RIDEWELL 1003587800C S-1505-C TRIANGLE 4333 4439
3B14-361 Flexmember 578-93-3-350		ASA-92-8-030 	ASA-92-6-013 	
3B14-364 Flexmember 578-93-3-350		ASA-92-8-100 	ASA-92-6-015 	Conti FT530-35455 HENDRICKSON B-7100 TRIANGLE 4455

- - Bolt or Stud 1/2-13 or 1/2-20
- ⊗ - Air Fitting - 1/4 NPTF
- - Stud - 3/4-10
- ⊕ - Tapped Hole on Top Retainers 3/8-16, on Pistons - 1/2-13
- ⊗ - Air Fitting - 1/2 NPTF or 3/8 NPTF
- ⊗ - Combination Stud Air Fitting Stud - 3/4-16; Air Fitting - 1/4 NPTF

Part No.	Side View With Extended And Compressed Height	Upper Mounting View	Lower Mounting View	Manufacturer Numbers
3B14-365 Flexmember 578-93-3-350		ASA-92-8-100 	ASA-92-6-015 	
3B14-367 Flexmember 578-93-3-350		ASA-92-8-100 	ASA-92-6-050 	Conti FT530-35457 DAYTON 354-7847 HENDRICKSON B-8874 TRIANGLE 4457
3B14-450 Flexmember 556-33-8-335		ASA-92-8-028 	ASA-92-6-013 	
3B14-451 Flexmember 578-93-3-335		ASA-92-8-100 	ASA-92-6-015 	Conti FT530-35456 FIRESTONE 7846 HENDRICKSON S-7853 TRIANGLE 4456
3B14-452 Flexmember 578-93-3-335		ASA-92-8-174 	ASA-92-6-056 	Conti FT530-35441 FIRESTONE 7850 HISTEER 10301 SUSPENSIONS INC. 200177 TRIANGLE 4441 WATSON & CHALIN AS-0086

- - Bolt or Stud 1/2-13 or 1/2-20
- ⊗ - Air Fitting - 1/4 NPTF
- - Stud - 3/4-10
- ◐ - Tapped Hole on Top Retainers 3/8-16, on Pistons - 1/2-13
- ⊗ - Air Fitting - 1/2 NPTF or 3/8 NPTF
- ⊗ - Combination Stud Air Fitting Stud - 3/4-16; Air Fitting - 1/4 NPTF

AIRSPRING BELLOWS

Part No.	Side View With Extended And Compressed Height	Upper Mounting View	Lower Mounting View	Manufacturer Numbers
3B14-455 Flexmember 556-33-8-335		ASA-92-8-031 	ASA-92-6-113 	
3B14-457 Flexmember 556-33-8-335		ASA-92-8-100 	ASA-92-6-015 	FIRESTONE 7843
3B14-459 Flexmember 556-33-8-335		ASA-92-8-100 	ASA-92-6-050 	FIRESTONE 7847
3B14-464 Flexmember 556-33-8-335		ASA-92-8-100 	ASA-92-6-013 	FIRESTONE 7862

- - Bolt or Stud 1/2-13 or 1/2-20
- ⊗ - Air Fitting - 1/4 NPTF
- - Stud - 3/4-10
- ⊙ - Tapped Hole on Top Retainers 3/8-16, on Pistons - 1/2-13
- ⊗ - Air Fitting - 1/2 NPTF or 3/8 NPTF
- ⊗ - Combination Stud Air Fitting Stud - 3/4-16; Air Fitting - 1/4 NPTF

Part No.	Side View With Extended And Compressed Height	Upper Mounting View	Lower Mounting View	Manufacturer Numbers
1R8-034 Flexmember 566-16-3-007 Piston 566-16-7-021		ASC-16-8-004 		FIRESTONE 5710 5730 FLXIBLE 6-304-156 6-336-175 GMC 10530086 6617550 698634 8870484 G5008051 LES AUTOBUS 10530086 698934 G5001705 NOVABUS G5001705 PREVOST 63-0226
1R8-036 Flexmember 566-16-3-007 Piston 566-16-7-000-03		ASC-16-8-003 		NOVABUS N16375 N21126
1R9-003 Flexmember 566-18-3-004 Piston 566-16-7-021		ASC-16-8-004 		AM GENERAL 5973923 FIRESTONE 5409 FLXIBLE 6-336-11 GMC 662743 NEW FLYER 5920815 5973877 5973923 5993113
1R9-025 Flexmember 566-18-3-010 Piston 566-16-7-017		ASC-16-8-004 		
1R9-038 Flexmember 566-18-3-010 Piston 566-16-7-017		ASC-16-8-004 		FIRESTONE 5406 GMC 2021085 667512A 667512C 716111 GRANNING 1971

- - Bolt or Stud 1/2-13 or 1/2-20
- ⊗ - Air Fitting - 1/4 NPTF
- - Stud - 3/4-10
- ⊗ (with dot) - Tapped Hole on Top Retainers 3/8-16, on Pistons - 1/2-13
- ⊗ (with cross) - Air Fitting - 1/2 NPTF or 3/8 NPTF
- ⊗ (with dot and cross) - Combination Stud Air Fitting Stud - 3/4-16; Air Fitting - 1/4 NPTF

AIRSPRING ROLLING LOBES

Part No.	Side View With Extended And Compressed Height	Upper Mounting View	Lower Mounting View	Manufacturer Numbers
1R9-047 <u>Flexmember</u> 566-18-3-004 <u>Piston</u> Not Included		ASC-16-8-004 	USE EXISTING GOODYEAR ENGINEERED PRODUCT PISTON	<u>FLXIBLE</u> 6-336-166
1R9-053 <u>Flexmember</u> 566-18-3-004 <u>Piston</u> 566-16-7-021		ASC-16-8-003 		<u>GMC</u> 672755 <u>MCI</u> 12L-4-212 12L-4-8
1R9-054 <u>Flexmember</u> 566-18-3-004 <u>Piston</u> 566-16-7-000		ASC-16-8-020 		<u>INT'L / NAVISTAR</u> 2013947C2
1R9-056 <u>Flexmember</u> 566-18-3-004 <u>Piston</u> 566-16-7-000		ASC-16-8-020 		<u>INT'L / NAVISTAR</u> 2013948C2
1R9-065 <u>Flexmember</u> 566-18-3-003 <u>Piston</u> 566-16-7-009		ASC-16-8-024 		<u>FIRESTONE</u> 2119 8997 <u>GRANNING</u> 5122 <u>HENDRICKSON</u> B-2394 <u>NEWAY</u> 905-57-029 905-57-034 <u>RIDEWELL</u> 1003588997C <u>TRIANGLE</u> 8525 <u>WATSON & CHALIN</u> AS-0026

- Bolt or Stud 1/2-13 or 1/2-20
- Tapped Hole on Top Retainers 3/8-16, on Pistons - 1/2-13
- Air Fitting - 1/4 NPTF
- Air Fitting - 1/2 NPTF or 3/8 NPTF
- Stud - 3/4-10
- Combination Stud Air Fitting Stud - 3/4-16; Air Fitting - 1/4 NPTF

Part No.	Side View With Extended And Compressed Height	Upper Mounting View	Lower Mounting View	Manufacturer Numbers
1R9-070 Flexmember 566-18-3-004 Piston 566-16-7-021		ASC-16-8-004 	ASC-16-7-021 	FIRESTONE 5410 GRANNING 2112 RIDEWELL 1003585410C TRIANGLE 8446 WATSON & CHALIN AS-0029
1R10-019 Flexmember 566-20-3-022 Piston 566-20-7-240		ASA-92-8-151 		FIRESTONE 9115 FLXIBLE 6-336-209 GMC 2475408 684242 716110
1R10-030 Flexmember 566-20-3-022 Piston Not Included		ASA-92-8-151 	USE EXISTING GOODYEAR ENGINEERED PRODUCTS PISTON	GMC 667513A 667513C 720414
1R10-072 Flexmember 566-20-3-029 Piston 566-20-7-055		ASA-92-8-162 		
1R10-085 Flexmember 566-20-3-021 Piston Not Included		ASA-92-8-151 	USE EXISTING GOODYEAR ENGINEERED PRODUCTS PISTON	FIRESTONE 9017 GMC 661759A 661759C 667302 677302 8875032 G1019449 LES AUTOBUS 661759C TMC 661759C

- - Bolt or Stud 1/2-13 or 1/2-20
- ⊗ - Air Fitting - 1/4 NPTF
- - Stud - 3/4-10
- ◐ - Tapped Hole on Top Retainers 3/8-16, on Pistons - 1/2-13
- ⊗ - Air Fitting - 1/2 NPTF or 3/8 NPTF
- ⊗ - Combination Stud Air Fitting Stud - 3/4-16; Air Fitting - 1/4 NPTF

AIRSPRING ROLLING LOBES

Part No.	Side View With Extended And Compressed Height	Upper Mounting View	Lower Mounting View	Manufacturer Numbers
1R10-087 Flexmember 566-20-3-021 Piston 566-20-7-240		ASA-92-8-152 		<u>BLUEBIRD</u> 990671 <u>FLXIBLE</u> 6-336-212 <u>GMC</u> G1019452 <u>PREVOST</u> 63-0067 63-0158
1R10-089 Flexmember 566-20-3-021 Piston 566-20-7-240		ASA-92-8-151 		<u>AUTO BUS</u> 10530087 <u>FIRESTONE</u> 9017 9067 9236HR 9386 9436 9610 <u>FLXIBLE</u> 6-304-157 6-336-174 6-841-92 97-240-153 <u>GMC</u> 10530087 661756 677302 684192 684193 684195-3 8870485 8875032 <u>NOVABUS</u> N15558 <u>PREVOST</u> 63-0044
1R10-090 Flexmember 566-20-3-021 Piston 566-20-7-120		ASA-92-8-151 		<u>GMC</u> 10530087 661756 684192 684193 6989635 G1019450 G1020957 <u>LES AUTOBUS</u> 10530087 698935 G5008052 <u>TMC</u> 10530087 684192 684193 6989635 G1020957
1R10-091 Flexmember 566-20-3-021 Piston 566-20-7-200		ASA-92-8-152 		<u>FIRESTONE</u> 9380 <u>FLXIBLE</u> 6-336-15 6-336-182 <u>GMC</u> 662744 <u>MCI</u> 12F-4-34 12L-4-261 12L-4-5 12M-4-6
1R10-099 Flexmember 566-20-3-021 Piston 566-20-7-240		ASA-92-8-309 		<u>DINA</u> 224-B020030 <u>MCI</u> 1496372

- - Bolt or Stud 1/2-13 or 1/2-20
- ⊗ - Air Fitting - 1/4 NPTF
- ⊙ - Stud - 3/4-10
- ⊕ - Tapped Hole on Top Retainers 3/8-16, on Pistons - 1/2-13
- ⊗ - Air Fitting - 1/2 NPTF or 3/8 NPTF
- ⊙ - Combination Stud Air Fitting Stud - 3/4-16; Air Fitting - 1/4 NPTF

Part No.	Side View With Extended And Compressed Height	Upper Mounting View	Lower Mounting View	Manufacturer Numbers
1R10-101 Flexmember 566-20-3-027 Piston 566-20-7-150		ASA-92-8-179 		FIRESTONE 5770 MCI 39390246
1R10-105 Flexmember 566-20-3-021 Piston 566-20-7-240		ASA-92-8-151 		FIRESTONE 9043 NOVABUS G1076863
1R10-108 Flexmember 566-20-3-021 Piston 566-20-7-120		ASA-92-8-152 		FIRESTONE 8899 PREVOST 63-0077
1R10-109 Flexmember 566-20-3-021 Piston 566-20-7-077-03		ASA-92-8-017 		ORION 020117511-4 T14-1044
1R10-118 Flexmember 566-20-3-021 Piston 566-20-7-240		ASA-92-8-179 		

- - Bolt or Stud 1/2-13 or 1/2-20
- ⊗ - Air Fitting - 1/4 NPTF
- - Stud - 3/4-10
- ⊗ (with dot) - Tapped Hole on Top Retainers 3/8-16, on Pistons - 1/2-13
- ⊗ (with cross) - Air Fitting - 1/2 NPTF or 3/8 NPTF
- ⊗ (with circle) - Combination Stud Air Fitting Stud - 3/4-16; Air Fitting - 1/4 NPTF

AIRSPRING ROLLING LOBES

Part No.	Side View With Extended And Compressed Height	Upper Mounting View	Lower Mounting View	Manufacturer Numbers
1R10-120 Flexmember 566-20-3-021 Piston 566-20-7-240		ASA-92-8-162 		Conti 99K-15P424 FIRESTONE 9293 NEWAY 905-57-120 TRIANGLE 8424
1R10-122 Flexmember 566-20-3-021 Piston 566-20-7-237		ASA-92-8-164 		Conti 99K-15P425 FIRESTONE 9291 NEWAY 905-57-122 905-57-139 TRIANGLE 8425
1R10-127 Flexmember 566-20-3-021 Piston 566-20-7-240		ASA-92-8-102 		ORION 20117526
1R10-133 Flexmember 566-20-3-021 Piston 566-20-7-240		ASA-92-8-152 		
1R10-137 Flexmember 566-20-3-023 Piston 566-20-7-240		ASA-92-8-429 		

- - Bolt or Stud 1/2-13 or 1/2-20
- ⊗ - Air Fitting - 1/4 NPTF
- - Stud - 3/4-10
- ⊙ - Tapped Hole on Top Retainers 3/8-16, on Pistons - 1/2-13
- ⊗ - Air Fitting - 1/2 NPTF or 3/8 NPTF
- ⊗ - Combination Stud Air Fitting Stud - 3/4-16; Air Fitting - 1/4 NPTF

Part No.	Side View With Extended And Compressed Height	Upper Mounting View	Lower Mounting View	Manufacturer Numbers
1R11-018 Flexmember 566-22-3-006 Piston 566-20-7-079	<p>18.5 7.2</p>	ASA-20-8-004 <p>4.76 7.50</p>	<p>4.12 10.12</p>	Conti 99-14A322 DAYTON 352-9073 352-9415 FIRESTONE 9415 HENDRICKSON B-7193 INT'L/ NAVISTAR 554761C1 KENWORTH K-102-A K-303-5 LOAD GUARD SC2049 RIDEWELL 1003589073C 1013580708C TAURUS AS103-9073 TRIANGLE 8322
1R11-028 Flexmember 566-22-3-021 Piston 566-20-7-014	<p>13.0 3.7</p>	ASA-92-8-024 <p>6.20 9.00</p>	<p>4.12 9.3</p>	Conti 99-12P314 DAYTON 352-9422 FIRESTONE 9422 INT'L/ NAVISTAR 554762C1 KENWORTH K-303-14 K-303-15 K-303-6 LOAD GUARD SC2050 TOYO TRL230H360382 TRIANGLE 8314 WATSON & CHALIN AS-0017
1R11-039 Flexmember 566-22-3-143 Piston 566-20-7-036	<p>17.0 6.1</p>	ASA-92-8-005 <p>6.20 9.00</p>	<p>7.87 10.10</p>	Conti 99-14A337 FIRESTONE 9439 TRIANGLE 8337
1R11-045 Flexmember 566-22-3-143 Piston 566-20-7-077-03	<p>18.0 6.0</p>	ASA-92-8-164 <p>5.5 9.00</p>	<p>4.12 9.50</p>	
1R11-047 Flexmember 566-22-3-021 Piston 566-20-7-014	<p>11.9 3.8</p>	ASA-92-8-005 <p>6.20 9.00</p>	<p>9.25</p>	MCI 12J-3-53

- - Bolt or Stud 1/2-13 or 1/2-20
- ⊗ - Air Fitting - 1/4 NPTF
- - Stud - 3/4-10
- ⊙ - Tapped Hole on Top Retainers 3/8-16, on Pistons - 1/2-13
- ⊗ - Air Fitting - 1/2 NPTF or 3/8 NPTF
- ⊗ - Combination Stud Air Fitting Stud - 3/4-16; Air Fitting - 1/4 NPTF

AIRSPRING ROLLING LOBES

Part No.	Side View With Extended And Compressed Height	Upper Mounting View	Lower Mounting View	Manufacturer Numbers
1R11-066 Flexmember 566-22-3-021 Piston 566-20-7-055	<p>13.0 4.7</p>	ASA-92-8-327 1.00-11.50 NPTF <p>2.75 6.20 9.00</p>	<p>8.60</p>	FIRESTONE 9447 RIDEWELL 1003589447C
1R11-075 Flexmember 566-22-3-028 Piston 566-20-7-055	<p>15.4 4.3</p>	AS1-92-8-163 <p>3.05 9.00</p>	<p>4.12 8.60</p>	
1R11-088 Flexmember 566-22-3-143 Piston 566-20-7-120	<p>18.3 8.1</p>	ASA-92-8-152 <p>4.76 9.00</p>	<p>4.12 9.98</p>	FIRESTONE 5739 PREVOST 63-0092 63-0104
1R11-090 Flexmember 566-22-3-143 Piston 566-20-7-079	<p>18.3 8.1</p>	ASA-92-8-438 1.250-12 UNF outside 500-14 NPTF inside <p>4.76 9.00</p>	<p>4.12 10.12</p>	PREVOST 63-0090 63-0094 63-0106
1R11-094 Flexmember 566-22-3-143 Piston 566-20-7-240	<p>18.0 6.4</p>	ASA-92-8-179 <p>5.50 9.00</p>	<p>9.27</p>	

- - Bolt or Stud 1/2-13 or 1/2-20
- ⊗ - Air Fitting - 1/4 NPTF
- ⊙ - Stud - 3/4-10
- ⊕ - Tapped Hole on Top Retainers 3/8-16, on Pistons - 1/2-13
- ⊗ - Air Fitting - 1/2 NPTF or 3/8 NPTF
- ⊗ - Combination Stud Air Fitting Stud - 3/4-16; Air Fitting - 1/4 NPTF

Part No.	Side View With Extended And Compressed Height	Upper Mounting View	Lower Mounting View	Manufacturer Numbers
1R11-097 Flexmember 566-22-3-044 Piston 566-20-7-079		ASA-92-8-152 		<u>PREVOST</u> 63-0129
1R11-115 Flexmember 566-22-3-051 Piston 566-20-7-183		ASA-92-8-271 500-14 NPTF 		<u>MCI</u> 12-03-1041
1R11-121 Flexmember 566-22-3-143 Piston 566-20-7-156		ASA-92-8-005 		<u>Conti</u> 99-14A337 <u>FIRESTONE</u> 9441 <u>FLXIBLE</u> 6-336-200 <u>GILLIG</u> 53-13187 53-14006 53-8212 <u>NOVABUS</u> N16374
1R11-130 Flexmember 566-22-3-049 Piston 566-20-7-124		ASA-92-8-005 		<u>NOVABUS</u> N17842
1R11-143 Flexmember 566-22-3-143 Piston 566-20-7-240		ASA-92-8-304 M22x 1.5-6G outside .250 18NPTF inside 		<u>DINA</u> 224-B020020 <u>MCI</u> 1512076

- - Bolt or Stud 1/2-13 or 1/2-20
- ⊗ - Air Fitting - 1/4 NPTF
- - Stud - 3/4-10
- ⊙ - Tapped Hole on Top Retainers 3/8-16, on Pistons - 1/2-13
- ⊗ - Air Fitting - 1/2 NPTF or 3/8 NPTF
- ⊗ - Combination Stud Air Fitting Stud - 3/4-16; Air Fitting - 1/4 NPTF

AIRSPRING ROLLING LOBES

Part No.	Side View With Extended And Compressed Height	Upper Mounting View	Lower Mounting View	Manufacturer Numbers
1R11-147 Flexmember 566-22-3-143 Piston 566-20-7-240		ASA-92-8-102 		ORION 20217501
1R11-149 Flexmember 566-22-3-143 Piston 566-20-7-239		ASA-92-8-142 		Conti 99-12P464 FIRESTONE 8901
1R11-150 Flexmember 566-22-3-021 Piston 566-20-7-055		ASA-92-8-162 		Conti 99-12P563 FIRESTONE 9448 RIDEWELL 1003589448C TRIANGLE 8563
1R11-151 Flexmember 566-22-3-021 Piston 566-20-7-055		ASA-92-8-162 		BLUEBIRD 1286814 FIRESTONE 9457 RIDEWELL 1003589457C
1R11-152 Flexmember 566-22-3-021 Piston 566-20-7-055		ASA-92-8-162 		CHANCE BUS 23891728 FIRESTONE 9459 RIDEWELL 1003589459C

- - Bolt or Stud 1/2-13 or 1/2-20
- ⊗ - Air Fitting - 1/4 NPTF
- - Stud - 3/4-10
- ⊙ - Tapped Hole on Top Retainers 3/8-16, on Pistons - 1/2-13
- ⊗ - Air Fitting - 1/2 NPTF or 3/8 NPTF
- ⊗ - Combination Stud Air Fitting Stud - 3/4-16; Air Fitting - 1/4 NPTF

Part No.	Side View With Extended And Compressed Height	Upper Mounting View	Lower Mounting View	Manufacturer Numbers
1R11-159 Flexmember 566-22-3-021 Piston 566-20-7-014		ASA-92-8-162 		Conti 99-12P479 FIRESTONE 9387
1R11-161 Flexmember 566-22-3-057 Piston 566-20-7-150		ASA-92-8-115 		AMERICAN CARRIER 8003-023 FIRESTONE 5766 HUTCHENS IND. 19141-01
1R11-162 Flexmember 566-22-3-021 Piston 566-20-7-014		ASA-92-8-164 		
1R11-166 Flexmember 566-22-3-143 Piston 566-20-7-235		ASA-92-8-164 		Conti 99K-15P417 FIRESTONE 9295 NEWAY 905-57-121 TRIANGLE 8417
1R11-169 Flexmember 566-22-3-143 Piston 566-20-7-250		ASA-92-8-151 		NOVABUS G1202328 G1202651 G1202652

- - Bolt or Stud 1/2-13 or 1/2-20
- ⊗ - Air Fitting - 1/4 NPTF
- ⊙ - Stud - 3/4-10
- ⊗ (with dot) - Tapped Hole on Top Retainers 3/8-16, on Pistons - 1/2-13
- ⊗ (with cross) - Air Fitting - 1/2 NPTF or 3/8 NPTF
- ⊗ (with dot and cross) - Combination Stud Air Fitting Stud - 3/4-16; Air Fitting - 1/4 NPTF

AIRSPRING ROLLING LOBES

Part No.	Side View With Extended And Compressed Height	Upper Mounting View	Lower Mounting View	Manufacturer Numbers
1R11-170 Flexmember 566-22-3-143 Piston 566-20-7-240		ASA-92-8-165 		
1R11-171 Flexmember 566-22-3-057 Piston 566-20-7-150		ASA-92-8-164 		<u>AMERICAN CARRIER</u> 8003-003 <u>Conti</u> 99-12P705 <u>FIRESTONE</u> 9421 <u>TRIANGLE</u> 8468
1R11-175 Flexmember 566-22-3-060 Piston 566-20-7-257		ASA-92-8-355 	M12 x 1.75-6G 	<u>INT'L / NAVISTAR</u> 3541733C1
1R11-178 Flexmember 566-22-3-143 Piston 566-20-7-209		ASA-92-8-005 		<u>Conti</u> 99-14P895 <u>NEW FLYER</u> 55089
1R11-179 Flexmember 566-22-3-143 Piston 566-20-7-209		ASA-92-8-005 		<u>Conti</u> 99-14P708 99K-15P708 <u>NEW FLYER</u> 99865

- Bolt or Stud 1/2-13 or 1/2-20
- Air Fitting - 1/4 NPTF
- Stud - 3/4-10
- Tapped Hole on Top Retainers 3/8-16, on Pistons - 1/2-13
- Air Fitting - 1/2 NPTF or 3/8 NPTF
- Combination Stud Air Fitting Stud - 3/4-16; Air Fitting - 1/4 NPTF

Part No.	Side View With Extended And Compressed Height	Upper Mounting View	Lower Mounting View	Manufacturer Numbers
1R11-189 Flexmember 566-22-3-049 Piston 566-20-7-240		ASA-92-8-309 		MCI 1498928
1R11-191 Flexmember 566-22-3-143 Piston 566-20-7-239		ASA-92-8-005 		Conti 99-14A517 99-14P517 FIRESTONE 8919 RIDEWELL 1003588919C TRIANGLE 8517
1R11-200 Flexmember 566-22-3-021 Piston 566-20-7-252		ASA-92-8-003 		Conti 99-12P477 FIRESTONE 9376 MCI 14002 MONOCO COACH 14002 TRIANGLE 8477
1R11-201 Flexmember 566-22-3-021 Piston 566-20-7-252		ASA-92-8-017 		Conti 99-12P478 FIRESTONE 9377 REYCO 21054-01 TRIANGLE 8478
1R11-202 Flexmember 566-22-3-021 Piston 566-20-7-252		ASA-92-8-164 		Conti 99-12P447 FIRESTONE 9378 RIDEWELL 1003589378C TRIANGLE 8447

- - Bolt or Stud 1/2-13 or 1/2-20
- ⊗ - Air Fitting - 1/4 NPTF
- - Stud - 3/4-10
- ⊙ - Tapped Hole on Top Retainers 3/8-16, on Pistons - 1/2-13
- ⊗ - Air Fitting - 1/2 NPTF or 3/8 NPTF
- ⊗ - Combination Stud Air Fitting Stud - 3/4-16; Air Fitting - 1/4 NPTF

AIRSPRING ROLLING LOBES

Part No.	Side View With Extended And Compressed Height	Upper Mounting View	Lower Mounting View	Manufacturer Numbers
1R11-203 Flexmember 566-22-3-021 Piston 566-20-7-251		ASA-92-8-164 		Conti 99-12P479 FIRESTONE 9387 RIDEWELL 1003589387C TRIANGLE 8479
1R11-204 Flexmember 566-22-3-021 Piston 566-20-7-253		ASA-92-8-164 		Conti 99-12P401 FIRESTONE 8900 REYCO 17361-01 TRIANGLE 8401
1R11-205 Flexmember 566-22-3-021 Piston 566-20-7-253		ASA-92-8-017 		Conti 99-12P516 FIRESTONE 9476 REYCO 20446-01 TRIANGLE 8516
1R11-216 Flexmember 566-22-3-068 Piston 566-20-7-257		ASA-92-8-355 	M12 x 1.75-6G 	
1R11-219 Flexmember 566-22-3-021 Piston 566-20-7-287		ASA-92-8-374 SAE 45° flare, 500 O.D. tube SAE J512, 750-16 UNF-2A 		Conti 99-9P860 FIRESTONE 9617 KENWORTH K-303-18 TRIANGLE 8514

- - Bolt or Stud 1/2-13 or 1/2-20
- ⊕ - Tapped Hole on Top Retainers 3/8-16, on Pistons - 1/2-13
- ⊗ - Air Fitting - 1/4 NPTF
- ⊗ - Air Fitting - 1/2 NPTF or 3/8 NPTF
- - Stud - 3/4-10
- ⊗ - Combination Stud Air Fitting Stud - 3/4-16; Air Fitting - 1/4 NPTF

Part No.	Side View With Extended And Compressed Height	Upper Mounting View	Lower Mounting View	Manufacturer Numbers
1R11-220 Flexmember 566-22-3-021 Piston 566-20-7-286		ASA-92-8-374 SAE 45 flare, 500 O.D. tube SAE J512, 750-16 UNF-2A 		<u>Conti</u> 99-10P862 <u>FIRESTONE</u> 9618 <u>KENWORTH</u> K-303-19
1R11-221 Flexmember 566-22-3-021 Piston 566-20-7-287		ASA-92-8-373 JIC 37 flare, 1.0 O.D. tube SAE J514, 1.312-12 UNF-2A 		<u>Conti</u> 99-10P576 <u>FIRESTONE</u> 9622 9675 W013589622 <u>KENWORTH</u> K-303-22 K-303-28 <u>TRIANGLE</u> 8537
1R11-222 Flexmember 566-22-3-021 Piston 566-20-7-286		ASA-92-8-373 JIC 37 flare, 1.0 O.D. tube SAE J514, 1.312-12 UNF-2A 		<u>Conti</u> 99-10P538 <u>FIRESTONE</u> 9625 <u>KENWORTH</u> K-303-25 <u>TRIANGLE</u> 8538
1R11-223 Flexmember 566-22-3-143 Piston 566-20-7-156		ASA-92-8-005 		<u>FIRESTONE</u> 9469
1R11-224 Flexmember 566-22-3-073 Piston 566-20-7-308		ASA-92-8-151 		





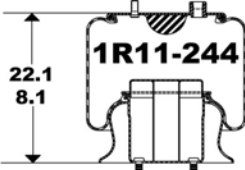
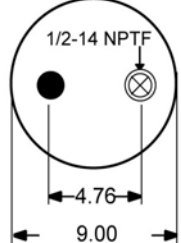
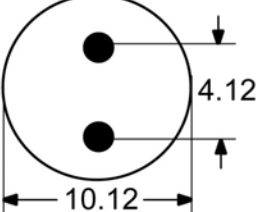
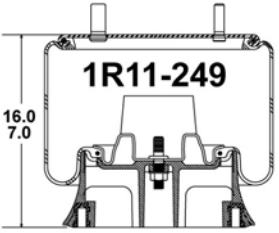
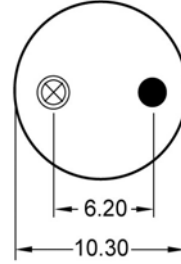
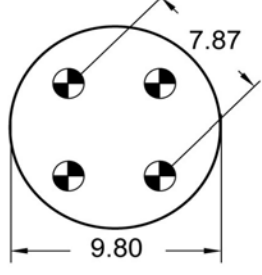
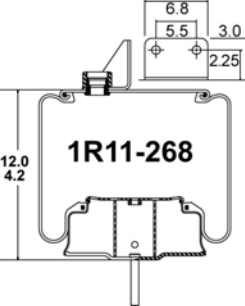
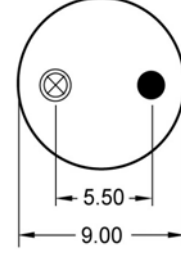
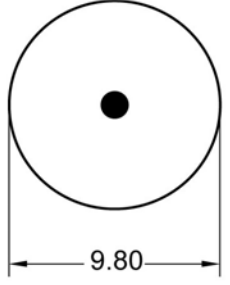
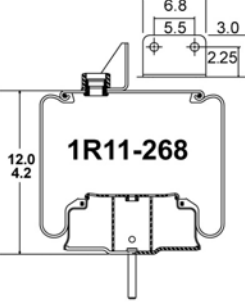
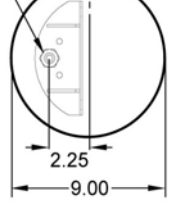
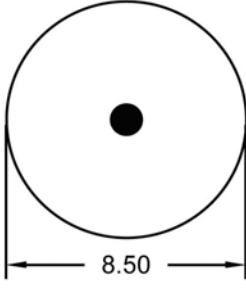
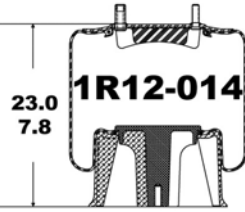
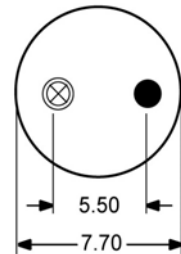
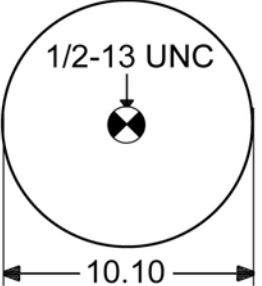

- Bolt or Stud 1/2-13 or 1/2-20
- Air Fitting - 1/4 NPTF
- Stud - 3/4-10
- Tapped Hole on Top Retainers 3/8-16, on Pistons - 1/2-13
- Air Fitting - 1/2 NPTF or 3/8 NPTF
- Combination Stud Air Fitting Stud - 3/4-16; Air Fitting - 1/4 NPTF

AIRSPRING ROLLING LOBES

Part No.	Side View With Extended And Compressed Height	Upper Mounting View	Lower Mounting View	Manufacturer Numbers
1R11-225 Flexmember 566-22-3-057 Piston 566-20-7-253		ASA-92-8-164 		FIRESTONE 9650 NEWAY 905-57-097
1R11-232 Flexmember 566-22-3-049 Piston 566-20-7-124		ASA-92-8-257 		
1R11-241 Flexmember 566-22-3-143 Piston 566-20-7-253		ASA-92-8-164 		
1R11-242 Flexmember 566-22-3-021 Piston 566-20-7-252		ASA-92-8-437 		Conti 99-12P515 FIRESTONE 9616 W01-358-9616 KENWORTH K-303-16 TRIANGLE 8515
1R11-243 Flexmember 566-22-3-143 Piston 566-20-7-120		ASA-92-8-438 		PREVOSTI 63-0093 63-0099 63-0105 63-0260

- - Bolt or Stud 1/2-13 or 1/2-20
- ⊗ - Air Fitting - 1/4 NPTF
- ⊙ - Stud - 3/4-10
- ⊕ - Tapped Hole on Top Retainers 3/8-16, on Pistons - 1/2-13
- ⊗ - Air Fitting - 1/2 NPTF or 3/8 NPTF
- ⊙ - Combination Stud Air Fitting Stud - 3/4-16; Air Fitting - 1/4 NPTF

Part No.	Side View With Extended And Compressed Height	Upper Mounting View	Lower Mounting View	Manufacturer Numbers
1R11-244 Flexmember 566-22-3-079 Piston 566-20-7-079		ASA-92-8-438 		<u>PREVOST</u> 63-0102 63-0126 63-0259
1R11-249 Flexmember 566-22-3-084 Piston 566-20-7-156		ASA-92-8-367 		
1R11-252 Flexmember 566-22-3-042 Piston 566-20-7-235		ASA-92-8-164 		
1R11-268 Flexmember 566-22-3-021 Piston 566-20-7-287		ASA-92-8-480 JIC 37 flare, 1.0 O.D. tube SAE J514, 1.312-12 UNF-2A 		<u>FIRESTONE</u> 9542 9547 W015449542
1R12-014 Flexmember 566-24-3-019 Piston 566-20-7-011		ASC-20-8-053 		<u>Conti</u> 910-16374M <u>DAYTON</u> 352-9098 <u>INT'L / NAVISTAR</u> 3541731C1 426212C1 426212C3 442306C91 454588C91 454590C1 <u>LOAD GUARD</u> SC2037

-  - Bolt or Stud 1/2-13 or 1/2-20
-  - Air Fitting - 1/4 NPTF
-  - Stud - 3/4-10
-  - Tapped Hole on Top Retainers 3/8-16, on Pistons - 1/2-13
-  - Air Fitting - 1/2 NPTF or 3/8 NPTF
-  - Combination Stud Air Fitting Stud - 3/4-16; Air Fitting - 1/4 NPTF

AIRSPRING ROLLING LOBES

Part No.	Side View With Extended And Compressed Height	Upper Mounting View	Lower Mounting View	Manufacturer Numbers
1R12-028 Flexmember 566-24-3-024 Piston 566-20-7-079		ASC-20-8-003 		<u>PREVOST</u> 63-0045
1R12-047 Flexmember 566-24-3-019 Piston 566-20-7-011		ASC-20-8-053 		<u>Conti</u> 910-16S374 <u>DAYTON</u> 352-9098 <u>FIRESTONE</u> 9098 <u>INT'L / NAVISTAR</u> 426212C1 426212C3 442305C91 442306C91 454588C91 454590C1 <u>LOAD GUARD</u> SC2057 <u>TRIANGLE</u> 8374
1R12-066 Flexmember 566-24-3-038 Piston 566-20-7-080		ASA-92-8-164 		<u>Conti</u> 910-16P333 <u>DAYTON</u> 352-9083 <u>FIRESTONE</u> 9083 <u>GRANNING</u> 1359 1528 B59 <u>INT'L / NAVISTAR</u> 554763C1 <u>LOAD GUARD</u> SC2036 <u>RIDEWELL</u> 1003589083C <u>TAURUS</u> AS506-9080 <u>TRIANGLE</u> 8333 <u>WATSON & CHALIN</u> AS-0018 AS-0028
1R12-069 Flexmember 566-24-3-038 Piston 566-20-7-235		ASA-92-8-041 		<u>Conti</u> 910-14P312 <u>DAYTON</u> 352-9069 <u>FIRESTONE</u> 9069 <u>INT'L / NAVISTAR</u> 554764C1 <u>LOAD GUARD</u> SC2034 <u>PETERBILT</u> 03-01649 03-02038 03-02456 03-04759 03-07112 23-10042 <u>TAURUS</u> AS504-9069 AS506-9069 <u>TRIANGLE</u> 8312 <u>WATSON & CHALIN</u> AS-0077
1R12-076 Flexmember 566-24-3-076 Piston 566-20-7-036		ASA-92-8-151 		<u>AM GENERAL</u> 5973924 <u>FIRESTONE</u> 9100

- - Bolt or Stud 1/2-13 or 1/2-20
- ⊗ - Air Fitting - 1/4 NPTF
- - Stud - 3/4-10
- ⊕ - Tapped Hole on Top Retainers 3/8-16, on Pistons - 1/2-13
- ⊗ - Air Fitting - 1/2 NPTF or 3/8 NPTF
- ⊗ - Combination Stud Air Fitting Stud - 3/4-16; Air Fitting - 1/4 NPTF

Part No.	Side View With Extended And Compressed Height	Upper Mounting View	Lower Mounting View	Manufacturer Numbers
1R12-090 Flexmember 566-24-3-038 Piston 566-20-7-079		ASA-92-8-052 		Conti 910-16P407 DAYTON 352-9213 FIRESTONE 9213 INT'L/ NAVISTAR 1660581C1 501559C1 501559C2 LOAD GUARD SC2048 TRIANGLE 8407
1R12-092 Flexmember 566-24-3-038 Piston 566-20-7-080		ASA-92-8-164 		Conti 910-16P310 910-16P350 DAYTON 352-9082 FAB TEK 101828 FIRESTONE 9082 GRANNING 2727 HDA PMABG-9082B HENDRICKSON 36514-7 B-2066 HUTCHENS IND. 9630-01 INT'L/ NAVISTAR 517559C9 KWIK-LOK / TODCO CP-3281 CP-5125 CP-5152 LOAD GUARD SC2035 NEWAY 905-57-006 905-57-027 905-57-037 905-57-054 905-57-075 AR-1315-1-F AR-1315-1-G R & S TRUCK & BODY 1090217 REYCO 12882-01 RIDEWELL 1003589082C S-542-C SUSPENSIONS INC. 201869 TAURUS AS506-9082 TOYO TRL-240/393 TRIANGLE 8310 WATSON & CHALIN AS-0011
1R12-093 Flexmember 566-24-3-038 Piston Not Included		ASA-92-8-164 	USE EXISTING GOODYEAR ENGINEERED PRODUCTS PISTON	HUTCHENS IND. 9630-03 INT'L/ NAVISTAR 554765C1 LOAD GUARD SC2054 NEWAY 900-44-200 900-44-216 900-44-647 RIDEWELL 1013580712C TAURUS AS506-0712

- - Bolt or Stud 1/2-13 or 1/2-20
- ⊗ - Air Fitting - 1/4 NPTF
- - Stud - 3/4-10
- ⊙ - Tapped Hole on Top Retainers 3/8-16, on Pistons - 1/2-13
- ⊗ - Air Fitting - 1/2 NPTF or 3/8 NPTF
- ⊗ - Combination Stud Air Fitting Stud - 3/4-16; Air Fitting - 1/4 NPTF

AIRSPRING ROLLING LOBES

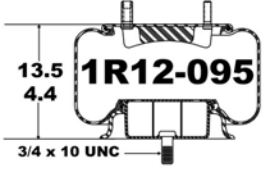
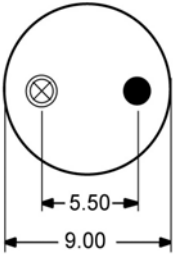
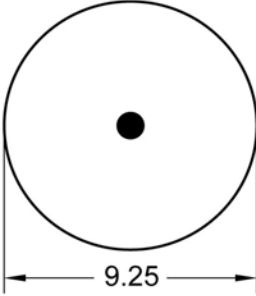
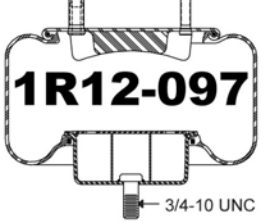
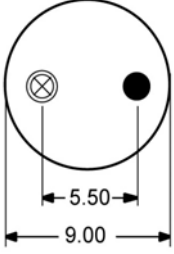
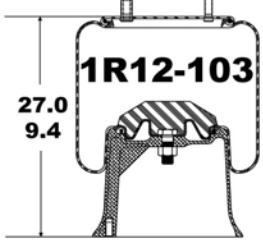
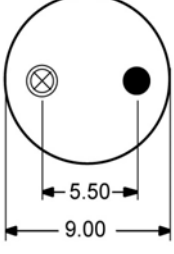
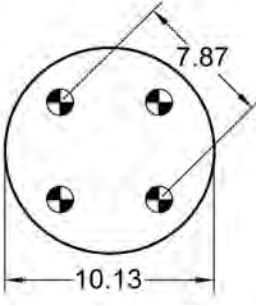
Part No.	Side View With Extended And Compressed Height	Upper Mounting View	Lower Mounting View	Manufacturer Numbers
1R12-095 Flexmember 566-24-3-067 Piston 566-20-7-014		ASA-92-8-162 		BLUEBIRD 12TA-1-2 300-961250 Conti 910-10P311 DAYTON 352-9039 FAB TEK 101827 FIRESTONE 9039 W013589039 FLXIBLE 6-336-202 HDA PMABG-9039B HENDRICKSON B-11650 B-2064 HUTCHENS IND. 9424-01 9424-03 INT'L / NAVISTAR 554766C1 LOAD GUARD SC2033 NEWAY 905-57-011 905-57-023 905-57-085 R & S TRUCK & BODY 1090218 RIDEWELL 1003589039C 1013589039C S-2061-C S-5356-C SAUR AXLES (SAS) P50-734 SUSPENSIONS INC. 200457 TAURUS AS500-9039 TRIANGLE 8311 WATSON & CHALIN AS-0012
1R12-097 Flexmember 566-24-3-067 Piston Not Included		ASA-92-8-162 	USE EXISTING GOODYEAR ENGINEERED PRODUCTS PISTON	HUTCHENS IND. 9424-1 INT'L / NAVISTAR 554767C1 LOAD GUARD SC2058 NEWAY 900-44-199 900-44-708 900-54-234 RIDEWELL 1013580702C TAURUS AS500-0702
1R12-103 Flexmember 566-24-3-066 Piston 566-20-7-006		ASA-92-8-164 		Conti 910-19P315 DAYTON 352-9101 FIRESTONE 9101 HENDRICKSON B-3842 INT'L / NAVISTAR 554768C1 LOAD GUARD SC2038 NEWAY 900-44-701 905-57-008 905-57-009 905-57-082 REYCO 12883-01 RIDEWELL 1003589101C S-5828-C S-740-C TAURUS AS506-9093 AS509-9101 TOYO TRL-250 TRIANGLE 8315 TRUCKSTELL 63647 WATSON & CHALIN AS-0040

- - Bolt or Stud 1/2-13 or 1/2-20
- ⊗ - Air Fitting - 1/4 NPTF
- - Stud - 3/4-10
- ⊙ - Tapped Hole on Top Retainers 3/8-16, on Pistons - 1/2-13
- ⊗ - Air Fitting - 1/2 NPTF or 3/8 NPTF
- ⊗ - Combination Stud Air Fitting Stud - 3/4-16; Air Fitting - 1/4 NPTF

Part No.	Side View With Extended And Compressed Height	Upper Mounting View	Lower Mounting View	Manufacturer Numbers
1R12-113 Flexmember 566-24-3-066 Piston Not Included		ASA-92-8-164 	USE EXISTING GOODYEAR ENGINEERED PRODUCTS PISTON	<u>INT'L / NAVISTAR</u> 554769C1 <u>LOAD GUARD</u> SC2053 <u>NEWAY</u> 900-44-201 900-44-653 900-54-218 <u>RIDEWELL</u> 1013589102C <u>TAURUS</u> AS509-9102
1R12-127 Flexmember 566-24-3-024 Piston 566-20-7-240		ASC-20-8-003 		<u>PREVOST</u> 63-0040
1R12-130 Flexmember 566-24-3-038 Piston 566-20-7-080		ASA-92-8-005 		<u>Conti</u> 910-16P353 <u>FIRESTONE</u> 9227 <u>HENDRICKSON</u> B-2924 <u>TRIANGLE</u> 8353
1R12-132 Flexmember 566-24-3-076 Piston 566-20-7-036		ASA-92-8-164 		<u>Conti</u> 910-12A319 910-12A341 910-12A343 910-12A504 910-12P319 <u>DAYTON</u> 352-9105 <u>FIRESTONE</u> 9105 9113 9302 9303 <u>GRANNING</u> 5065 <u>HDA</u> PMABG-9105B <u>HENDRICKSON</u> 36514-3 B-1245 <u>INT'L / NAVISTAR</u> 554770C1 <u>LOAD GUARD</u> SC2039 <u>R & S TRUCK & BODY</u> 1090276 <u>RIDEWELL</u> 1003580725C 1003589105C S-570-C <u>SAUR AXLES (SAS)</u> P50-705 <u>TAURUS</u> AS302-9302 AS502-0725 AS502-9105 AS502-9113 <u>TRIANGLE</u> 8319 <u>WATSON & CHALIN</u> AS-0015

- - Bolt or Stud 1/2-13 or 1/2-20
- ⊗ - Air Fitting - 1/4 NPTF
- - Stud - 3/4-10
- ◐ - Tapped Hole on Top Retainers 3/8-16, on Pistons - 1/2-13
- ⊗ - Air Fitting - 1/2 NPTF or 3/8 NPTF
- ⊗ - Combination Stud Air Fitting Stud - 3/4-16; Air Fitting - 1/4 NPTF

AIRSPRING ROLLING LOBES

Part No.	Side View With Extended And Compressed Height	Upper Mounting View	Lower Mounting View	Manufacturer Numbers
1R12-139 Flexmember 566-24-3-076 Piston 566-20-7-006	<p>18.7 12.5</p> <p>1R12-139</p>	ASA-92-8-098 <p>6.20 9.00</p>	<p>7.87 10.13</p>	MCI 12J-1-23
1R12-142 Flexmember 566-24-3-066 Piston 566-20-7-006	<p>27.0 9.4</p> <p>1R12-142</p>	ASA-92-8-005 <p>6.20 9.00</p>	<p>7.87 10.13</p>	INT'L/ NAVISTAR 1681579C1 LOAD GUARD SC2108 SUSPENSIONS INC. 200041
1R12-143 Flexmember 566-24-3-048 Piston 566-20-7-006	<p>22.9 9.5</p> <p>1R12-143</p>	ASC-20-8-045 <p>5.50 7.70</p>	<p>7.87 10.13</p>	Conti 910-16P376 FIRESTONE 9392 HENDRICKSON B-4773 TRIANGLE 8376
1R12-145 Flexmember 566-24-3-066 Piston 566-20-7-006	<p>27.0 9.4</p> <p>1R12-145</p>	ASA-92-8-017 <p>5.50 9.00</p>	<p>7.87 10.13</p>	Conti 910-19P356 DAYTON 352-9238 FIRESTONE 9238 HENDRICKSON B-5060 INT'L/ NAVISTAR 1681737C1 LOAD GUARD SC2109 PREVOST 63-0178 TAURUS AS509-9238 TRIANGLE 8356
1R12-154 Flexmember 566-24-3-048 Piston 566-20-7-120	<p>17.1 8.0</p> <p>1R12-154</p>	ASC-20-8-053 <p>5.50 7.70</p>	<p>4.12 10.0</p>	MCI 12J-1-88

- - Bolt or Stud 1/2-13 or 1/2-20
- ⊗ - Air Fitting - 1/4 NPTF
- - Stud - 3/4-10
- ⊙ - Tapped Hole on Top Retainers 3/8-16, on Pistons - 1/2-13
- ⊗ - Air Fitting - 1/2 NPTF or 3/8 NPTF
- ⊗ - Combination Stud Air Fitting Stud - 3/4-16; Air Fitting - 1/4 NPTF

Part No.	Side View With Extended And Compressed Height	Upper Mounting View	Lower Mounting View	Manufacturer Numbers
1R12-155 Flexmember 566-24-3-038 Piston 566-20-7-080		ASA-92-8-002 		<u>Conti</u> 910-16P325 <u>FIRESTONE</u> 9096 <u>FRUEHAUF</u> UCE-1304-1 <u>TRIANGLE</u> 8325
1R12-156 Flexmember 566-24-3-067 Piston 566-20-7-055		ASA-92-8-005 		<u>MCI</u> 12K-3-11 <u>PREVOST</u> 63-0179
1R12-158 Flexmember 566-24-3-090 Piston <u>Not Included</u>		ASA-92-8-164 	<p align="center">USE EXISTING GOODYEAR ENGINEERED PRODUCTS PISTON</p>	
1R12-162 Flexmember 566-24-3-066 Piston <u>Not Included</u>		ASA-92-8-164 	<p align="center">USE EXISTING GOODYEAR ENGINEERED PRODUCTS PISTON</p>	
1R12-167 Flexmember 566-24-3-066 Piston 566-20-7-080		ASA-92-8-164 		<u>Conti</u> 910-19P326 <u>INT'L /</u> <u>NAVISTAR</u> 1681738C1 1681740C1

- Bolt or Stud 1/2-13 or 1/2-20
- Air Fitting - 1/4 NPTF
- Stud - 3/4-10
- Tapped Hole on Top Retainers 3/8-16, on Pistons - 1/2-13
- Air Fitting - 1/2 NPTF or 3/8 NPTF
- Combination Stud Air Fitting Stud - 3/4-16; Air Fitting - 1/4 NPTF

AIRSPRING ROLLING LOBES

Part No.	Side View With Extended And Compressed Height	Upper Mounting View	Lower Mounting View	Manufacturer Numbers
1R12-169 Flexmember 566-24-3-076 Piston 566-20-7-036-03	<p>16.7 7.3</p>	ASA-92-8-119 <p>2.88 6.20 9.00</p>	<p>7.87 10.10</p>	<u>FLXIBLE</u> 97-2410-0006 97-2410-1 97-2410-2 97-2410-3 97-2410-4 97-2410-5 97-6693-1
1R12-178 Flexmember 566-24-3-067 Piston 566-20-7-055	<p>13.5 5.1</p>	ASA-92-8-125 <p>5.50 9.00</p>	<p>4.12 8.60</p>	<u>Conti</u> 99-12P379 <u>FIRESTONE</u> 9379 <u>INT'L / NAVISTAR</u> 1660694C1 <u>LOAD GUARD</u> SC2110 <u>TRIANGLE</u> 8379
1R12-182 Flexmember 566-24-3-038 Piston 566-20-7-079	<p>20.5 6.2</p>	ASA-92-8-004 <p>5.50 9.00</p>	<p>4.12 10.12</p>	<u>Conti</u> 910-16P408 <u>FIRESTONE</u> 9219 <u>INT'L / NAVISTAR</u> 1681739C1 <u>LOAD GUARD</u> SC2070 <u>TRIANGLE</u> 8408 <u>VOLVO</u> 35003-3201 35003-3203
1R12-185 Flexmember 566-24-3-066 Piston 566-20-7-080	<p>25.2 7.6</p>	ASA-92-8-164 <p>5.50 9.00</p>	<p>7.87 10.13</p>	<u>FIRESTONE</u> 9192 <u>HENDRICKSON</u> S6195
1R12-188 Flexmember 566-24-3-038 Piston 566-20-7-079	<p>20.5 7.1</p>	ASA-92-8-162 <p>5.50 9.00</p>	<p>4.12 10.12</p>	<u>Conti</u> 910-16P409 <u>FIRESTONE</u> 9223 <u>HENDRICKSON</u> 48195 <u>REYCO</u> 12884-01 12884-01A <u>TRIANGLE</u> 8409

- - Bolt or Stud 1/2-13 or 1/2-20
- ⊗ - Air Fitting - 1/4 NPTF
- - Stud - 3/4-10
- ⊕ - Tapped Hole on Top Retainers 3/8-16, on Pistons - 1/2-13
- ⊗ - Air Fitting - 1/2 NPTF or 3/8 NPTF
- ⊗ - Combination Stud Air Fitting Stud - 3/4-16; Air Fitting - 1/4 NPTF

Part No.	Side View With Extended And Compressed Height	Upper Mounting View	Lower Mounting View	Manufacturer Numbers
1R12-195 Flexmember 566-24-3-066 Piston 566-20-7-006	<p>28.5 9.4</p>	ASA-92-8-257 <p>9.00 4.75 1.50</p>	<p>10.13 7.87</p>	<u>Conti</u> 910-19P438 <u>FIRESTONE</u> 9349 <u>HENDRICKSON</u> B-8988 <u>REYCO</u> 17636-01 <u>TRIANGLE</u> 8438
1R12-204 Flexmember 566-24-3-067 Piston 566-20-7-055	<p>13.5 3.7</p>	ASA-92-8-138 <p>9.00 5.50</p>	<p>8.60 4.12</p>	<u>FIRESTONE</u> 9566 <u>INT'L / NAVISTAR</u> 1672401C1
1R12-205 Flexmember 566-24-3-076 Piston 566-20-7-055	<p>16.0 5.1</p>	ASA-92-8-125 <p>9.00 5.50</p>	<p>8.60 4.12</p>	<u>Conti</u> 910-14P450 <u>FIRESTONE</u> 9568 <u>INT'L / NAVISTAR</u> 1675495C1 <u>TRIANGLE</u> 8450
1R12-208 Flexmember 566-24-3-066 Piston 566-207-006	<p>27.0 9.5</p>	ASA-92-8-141 3/4 - 14 NPTF <p>9.00 6.20 2.87</p>	<p>10.13 7.87</p>	<u>HENDRICKSON</u> C-10443
1R12-217 Flexmember 566-24-3-048 Piston 566-20-7-120	<p>17.1 7.3</p>	UPPER BEAD PLATE NOT INCLUDED. SHOWN FOR REFERENCE ONLY.	<p>10.0 4.12</p>	<u>MCI</u> 12L-1-104 12L-1-136 <u>PREVOST</u> 63-0181

- Bolt or Stud 1/2-13 or 1/2-20
- Air Fitting - 1/4 NPTF
- Stud - 3/4-10
- Tapped Hole on Top Retainers 3/8-16, on Pistons - 1/2-13
- Air Fitting - 1/2 NPTF or 3/8 NPTF
- Combination Stud Air Fitting Stud - 3/4-16; Air Fitting - 1/4 NPTF

AIRSPRING ROLLING LOBES

Part No.	Side View With Extended And Compressed Height	Upper Mounting View	Lower Mounting View	Manufacturer Numbers
1R12-220 Flexmember 566-24-3-038 Piston 566-20-7-080	<p>21.1 7.7</p>	ASA-92-8-164 <p>5.50 9.00</p>	<p>7.87 10.10</p>	Conti 910-16P372 FIRESTONE 9092 HENDRICKSON B-12353 INT'L/ NAVISTAR 517096C91 NEWAY 905-57-031 TRIANGLE 8372
1R12-256 Flexmember 566-24-3-090 Piston 566-20-7-159	<p>29.1 9.5</p>	ASA-92-8-142 <p>6.20 9.00</p>	<p>7.87 9.80</p>	Conti 910-21A505 910-21P505 FIRESTONE 9367 HENDRICKSON B-14249 B-4375 LOAD GUARD SC2120 SUSPENSIONS INC. 201335 TRIANGLE 8505 WATSON & CHALIN AS-0104
1R12-261 Flexmember 566-24-3-066 Piston 566-20-7-006	<p>27.0 9.4</p>	ASA-92-8-005 <p>6.20 9.00</p>	<p>7.87 10.10</p>	Conti 910-19Pxxx DAYTON 352-9321 FIRESTONE 9241 R & S TRUCK & BODY 10907 TAURUS AS509-9241 TRIANGLE 8358 8361
1R12-265 Flexmember 566-24-3-066 Piston 566-20-7-080	<p>25.2 7.7</p>	ASA-92-8-164 <p>5.50 9.00</p>	<p>7.87 10.10</p>	Conti 910-19P390
1R12-274 Flexmember 566-24-3-097 Piston 566-20-7-079	<p>22.8 8.1</p>	ASA-92-8-121 <p>6.20 9.00</p>	<p>4.12 10.12</p>	



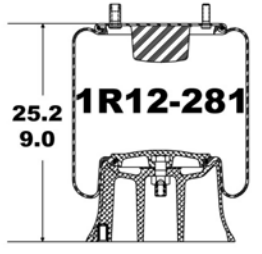
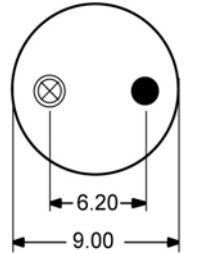
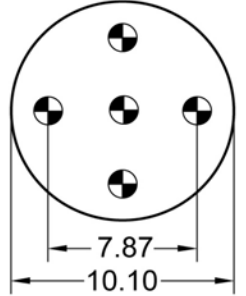
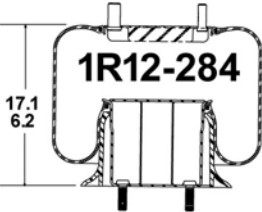
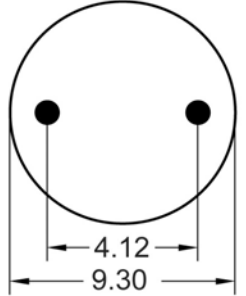
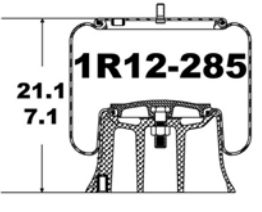
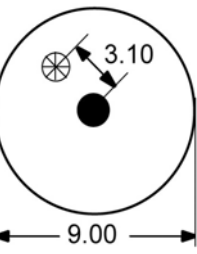
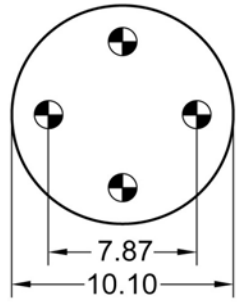
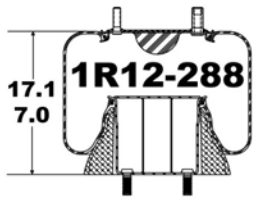
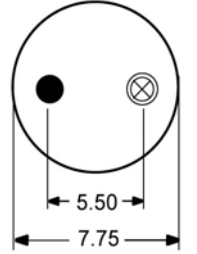
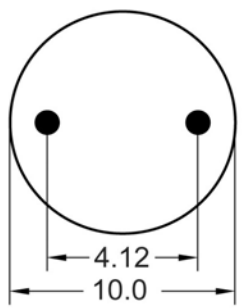
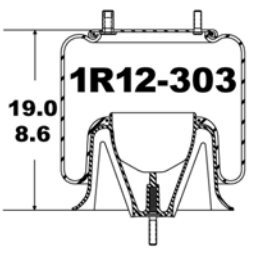
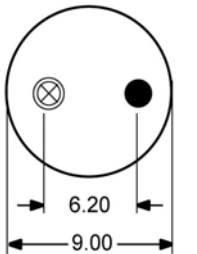
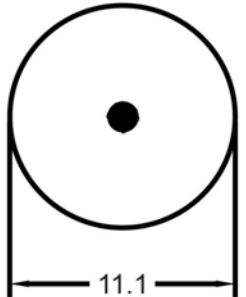

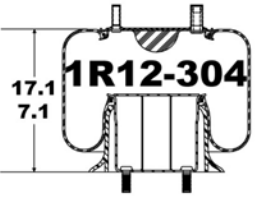
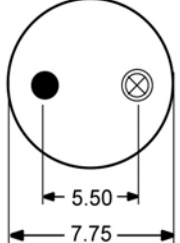
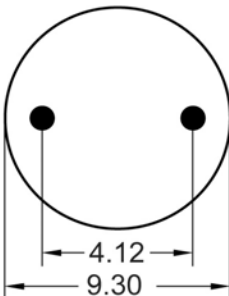
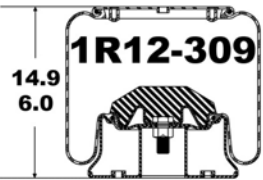
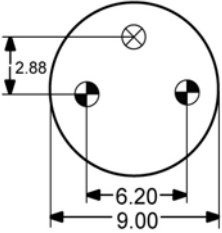
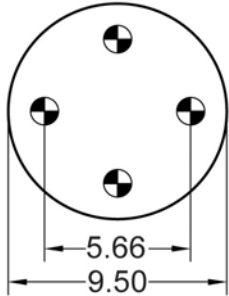
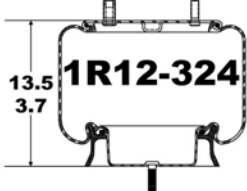
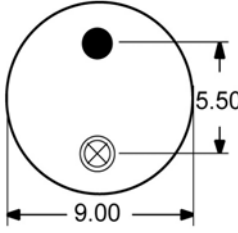
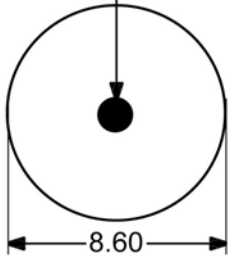
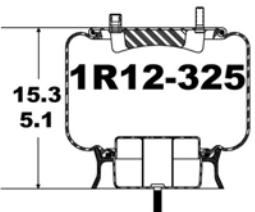
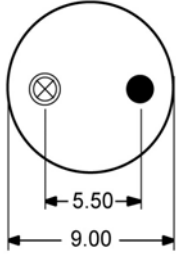
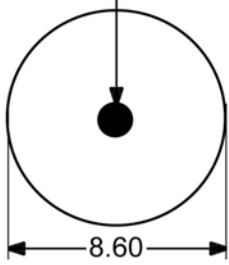
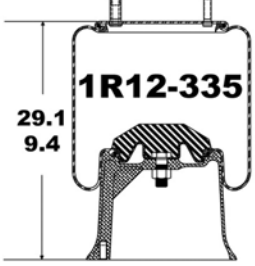
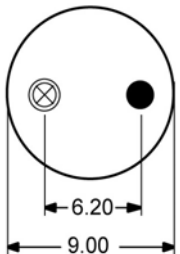
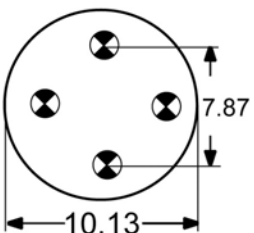

- - Bolt or Stud 1/2-13 or 1/2-20
- ⊗ - Air Fitting - 1/4 NPTF
- ⊙ - Stud - 3/4-10
- ⊕ - Tapped Hole on Top Retainers 3/8-16, on Pistons - 1/2-13
- ⊗ - Air Fitting - 1/2 NPTF or 3/8 NPTF
- ⊗ - Combination Stud Air Fitting Stud - 3/4-16; Air Fitting - 1/4 NPTF

Part No.	Side View With Extended And Compressed Height	Upper Mounting View	Lower Mounting View	Manufacturer Numbers
1R12-281 Flexmember 566-24-3-066 Piston 566-20-7-080		ASA-92-8-121 		Conti 910-19A358 910-19P321 910-19P358 DAYTON 352-9130 FIRESTONE 9130 FRUEHAUF UCE-9393-1 UCE-9393-3 UCE-9393-4 TRIANGLE 8321
1R12-284 Flexmember 566-24-3-048 Piston 566-20-7-240		UPPER BEAD PLATE NOT INCLUDED. SHOWN FOR REFERENCE ONLY.		
1R12-285 Flexmember 566-24-3-038 Piston 566-20-7-080		ASC-92-8-088 		Conti 910-14P709 NEW FLYER 14635 65
1R12-288 Flexmember 566-24-3-048 Piston 566-20-7-120		ASC-20-8-110 		MCI 12K-1-45 12L-1-126 PREVOST 63-0180
1R12-303 Flexmember 566-24-3-108 Piston 566-20-7-116		ASA-92-8-440 		Conti 910S-16A382 910S-16P382 FIRESTONE 5779 W013589780 FREIGHTLINER 16-13810-000 16-13810-001 16-13810-002 16-15595-000 16-15595-001 16-15595-002 TRIANGLE 8382

- - Bolt or Stud 1/2-13 or 1/2-20
- ⊗ - Air Fitting - 1/4 NPTF
- - Stud - 3/4-10
- ◐ - Tapped Hole on Top Retainers 3/8-16, on Pistons - 1/2-13
- ⊗ - Air Fitting - 1/2 NPTF or 3/8 NPTF
- ⊗ - Combination Stud Air Fitting Stud - 3/4-16; Air Fitting - 1/4 NPTF

AIRSPRING ROLLING LOBES

Part No.	Side View With Extended And Compressed Height	Upper Mounting View	Lower Mounting View	Manufacturer Numbers
1R12-304 Flexmember 566-24-3-048 Piston 566-20-7-240		ASC-20-8-110 		FIRESTONE 9018 MCI 12G-1-60 12L-1-133 12L-1-135 12L-1-142 PREVOST 63-0182
1R12-309 Flexmember 566-24-3-067 Piston 566-20-7-164		ASA-92-8-002 		Conti 910-12A327 DAYTON 352-9053 E-Z RIDE 8030192 FAB TEK 10828 FIRESTONE 9053 FRUEHAUF UCE-1304-2 RIDEWELL 1003589053C TAURUS AS502-9053 TRIANGLE 8327 WATSON & CHALIN AS-0095
1R12-324 Flexmember 566-24-3-067 Piston 566-20-7-055		ASA-92-8-138 	M12x1.75-6g 	FIRESTONE 9565 INT'L/ NAVISTAR 2027912C1
1R12-325 Flexmember 566-24-3-076 Piston 566-20-7-055		ASA-92-8-125 	M12x1.75-6g 	Conti 910-14P461 FIRESTONE 9567 INT'L/ NAVISTAR 2027913C1 TRIANGLE 8461
1R12-335 Flexmember 566-24-3-090 Piston 566-20-7-006		ASA-92-8-142 		Conti 910-21A361 910-21P361 FIRESTONE 9321 WATSON & CHALIN AS-0036

-  - Bolt or Stud 1/2-13 or 1/2-20
-  - Air Fitting - 1/4 NPTF
-  - Stud - 3/4-10
-  - Tapped Hole on Top Retainers 3/8-16, on Pistons - 1/2-13
-  - Air Fitting - 1/2 NPTF or 3/8 NPTF
-  - Combination Stud Air Fitting Stud - 3/4-16; Air Fitting - 1/4 NPTF

Part No.	Side View With Extended And Compressed Height	Upper Mounting View	Lower Mounting View	Manufacturer Numbers
1R12-350 Flexmember 566-24-3-061 Piston 566-20-7-197		ASA-92-8-002 		<u>Conti</u> 910-10P339 <u>FIRESTONE</u> 9031 <u>PEERLESS</u> 0550-00051 <u>TAURUS</u> AS500-9031 <u>TRIANGLE</u> 8339
1R12-351 Flexmember 566-24-3-061 Piston 566-20-7-197		ASA-92-8-003 		<u>Conti</u> 910-10P328 <u>FIRESTONE</u> 9033 <u>NEWAY</u> 905-57-012 AR-1515-1 <u>TAURUS</u> AS500-9033 <u>TRIANGLE</u> 8328
1R12-352 Flexmember 566-24-3-076 Piston 566-20-7-080		ASA-92-8-004 		<u>Conti</u> 910-14P345 <u>HENDRICKSON</u> B-2827
1R12-355 Flexmember 566-24-3-076 Piston 566-20-7-036		ASA-92-8-088 		<u>Conti</u> 910-12A329 910-12P329 <u>FIRESTONE</u> 9078 <u>FRUEHAUF</u> MFR-022355 UCB-9668-1 <u>TRIANGLE</u> 8329
1R12-356 Flexmember 566-24-3-038 Piston 566-20-7-080		ASA-92-8-258 1.25-12 UNF outside .500-14 NPTF inside 		<u>Conti</u> 910-16P352 <u>DAYTON</u> 352-9194 <u>FIRESTONE</u> 9194 <u>PETERBILT</u> 03-05107 <u>TAURUS</u> AS506-9194 <u>TRIANGLE</u> 8352 <u>WATSON &</u> <u>CHALIN</u> AS-0101





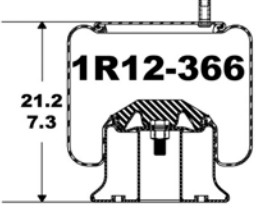
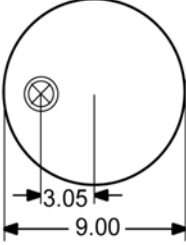
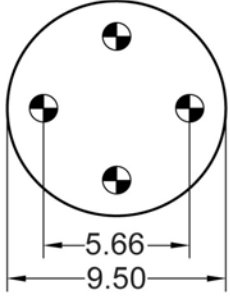
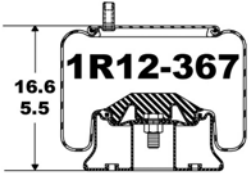
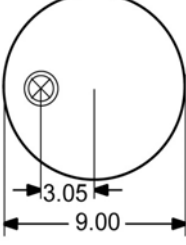
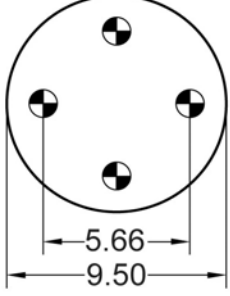
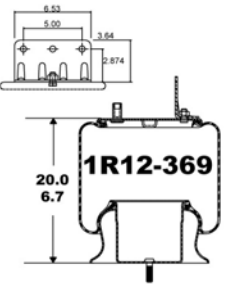
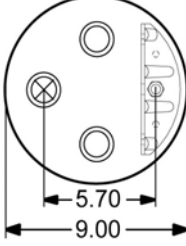
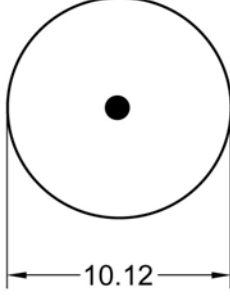
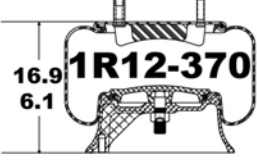
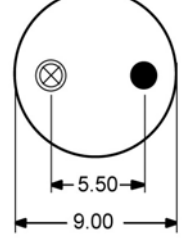
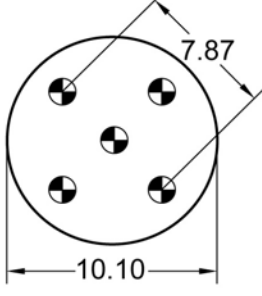
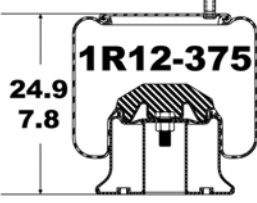
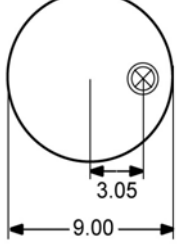
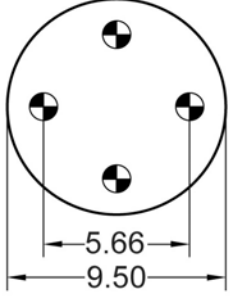

- - Bolt or Stud 1/2-13 or 1/2-20
- ⊗ - Air Fitting - 1/4 NPTF
- - Stud - 3/4-10
- ⊙ - Tapped Hole on Top Retainers 3/8-16, on Pistons - 1/2-13
- ⊗ - Air Fitting - 1/2 NPTF or 3/8 NPTF
- ⊗ - Combination Stud Air Fitting Stud - 3/4-16; Air Fitting - 1/4 NPTF

AIRSPRING ROLLING LOBES

Part No.	Side View With Extended And Compressed Height	Upper Mounting View	Lower Mounting View	Manufacturer Numbers
1R12-357 Flexmember 566-24-3-066 Piston 566-20-7-006	<p>27.0 10.7</p>	ASA-92-8-257 		Conti 910-19P439 FIRESTONE 9348 TAURUS AS509-9348
1R12-358 Flexmember 566-24-3-038 Piston 566-20-7-080	<p>21.1 7.7</p>	ASA-92-8-003 		Conti 910-16P325 DAYTON 352-9096 FIRESTONE 9096 FRUEHAUF UCE-1304-1 TAURUS AS504-9096 TRIANGLE 8325
1R12-359 Flexmember 566-24-3-061 Piston 566-20-7-197	<p>13.1 5.3</p>	ASA-92-8-088 		Conti 910-10P331 FIRESTONE 9077 FRUEHAUF MFR-022354 UCB-4453-1 TAURUS AS500-9077 TRIANGLE 8331
1R12-363 Flexmember 566-24-3-090 Piston 566-20-7-159	<p>29.1 9.5</p>	ASA-92-8-164 		Conti 910-21P360 FIRESTONE 9320 NEWAY 905-57-099 TRIANGLE 8360
1R12-365 Flexmember 566-24-3-038 Piston 566-20-7-079	<p>20.6 8.1</p>	ASA-92-8-121 		Conti 910-16P410 FIRESTONE 9466 HENDRICKSON 49048 49674 MACK TRUCK 364SQ28 57QL411M TRIANGLE 8410

- - Bolt or Stud 1/2-13 or 1/2-20
- ⊗ - Air Fitting - 1/4 NPTF
- - Stud - 3/4-10
- ⊕ - Tapped Hole on Top Retainers 3/8-16, on Pistons - 1/2-13
- ⊗ - Air Fitting - 1/2 NPTF or 3/8 NPTF
- ⊗ - Combination Stud Air Fitting Stud - 3/4-16; Air Fitting - 1/4 NPTF

Part No.	Side View With Extended And Compressed Height	Upper Mounting View	Lower Mounting View	Manufacturer Numbers
1R12-366 Flexmember 566-24-3-038 Piston 566-20-7-163		AS1-92-8-192 		<u>Conti</u> 910-16P710 910-175P436 <u>FIRESTONE</u> 8944 9015 9299 <u>HENDRICKSON</u> C-20217 <u>TRIANGLE</u> 8436
1R12-367 Flexmember 566-24-3-076 Piston 566-20-7-164		ASC-92-8-192 		<u>Conti</u> 910-12A427 <u>FIRESTONE</u> 9640 <u>HENDRICKSON</u> C-20223 <u>TRIANGLE</u> 8427
1R12-369 Flexmember 566-24-3-038 Piston 566-20-7-079		ASA-92-8-165 		<u>DINA</u> 2027911C1
1R12-370 Flexmember 566-24-3-076 Piston 566-20-7-036		ASA-92-8-162 		<u>Conti</u> 910-14A330 <u>FIRESTONE</u> 9070 <u>NEWAY</u> 905-57-038-1 905-57-090 AR-90112 <u>TAURUS</u> AS504-9070 <u>TRIANGLE</u> 8330 8490 <u>WATSON & CHALIN</u> AS-0050 AS-0053
1R12-375 Flexmember 566-24-3-066 Piston 566-20-7-163		ASA-92-8-192 		<u>Conti</u> 910-19P435 <u>FIRESTONE</u> 9265 W013589265 <u>HENDRICKSON</u> C-20124 <u>TRIANGLE</u> 8435

-  - Bolt or Stud 1/2-13 or 1/2-20
-  - Tapped Hole on Top Retainers 3/8-16, on Pistons - 1/2-13
-  - Air Fitting - 1/4 NPTF
-  - Air Fitting - 1/2 NPTF or 3/8 NPTF
-  - Stud - 3/4-10
-  - Combination Stud Air Fitting Stud - 3/4-16; Air Fitting - 1/4 NPTF

AIRSPRING ROLLING LOBES

Part No.	Side View With Extended And Compressed Height	Upper Mounting View	Lower Mounting View	Manufacturer Numbers
1R12-383 Flexmember 566-24-3-061 Piston 566-20-7-014		ASA-92-8-162 		<u>FLXIBLE</u> 97-9999-02185 <u>ORION</u> 010132404-4
1R12-394 Flexmember 566-24-3-038 Piston Not Included		ASA-92-8-283 	USE EXISTING GOODYEAR ENGINEERED PRODUCT PISTON	<u>MCI</u> 12L-1-169 <u>PREVOST</u> 63-0224
1R12-395 Flexmember 566-24-3-066 Piston 566-20-7-080		ASA-92-8-005 		<u>Conti</u> 910-19P355 <u>DAYTON</u> 352-9203 <u>FIRESTONE</u> 9203 <u>HENDRICKSON</u> B-2694 <u>TAURUS</u> AS509-9203 <u>TRIANGLE</u> 8355
1R12-396 Flexmember 566-24-3-038 Piston 566-20-7-240		ASA-92-8-283 		<u>MCI</u> 12L-1-140 <u>PREVOST</u> 63-0183
1R12-400 Flexmember 566-24-3-038 Piston 566-20-7-246		ASA-92-8-306 		<u>Conti</u> 910-16P416 <u>FIRESTONE</u> 9296 <u>TRIANGLE</u> 8416 <u>VOLVO</u> 8061151 8169868

- Bolt or Stud 1/2-13 or 1/2-20
- Air Fitting - 1/4 NPTF
- Stud - 3/4-10
- Tapped Hole on Top Retainers 3/8-16, on Pistons - 1/2-13
- Air Fitting - 1/2 NPTF or 3/8 NPTF
- Combination Stud Air Fitting Stud - 3/4-16; Air Fitting - 1/4 NPTF

Part No.	Side View With Extended And Compressed Height	Upper Mounting View	Lower Mounting View	Manufacturer Numbers
1R12-401 Flexmember 566-24-3-038 Piston 566-20-7-221		ASA-92-8-165 		<u>Conti</u> 910-175P521 910-185P521 <u>FIRESTONE</u> 9371 <u>INT'L/</u> <u>NAVISTAR</u> 1670043C1 1686386C1 <u>TRIANGLE</u> 8521
1R12-402 Flexmember 566-24-3-097 Piston 566-20-7-246		ASA-92-8-199 		<u>Conti</u> 910-175P520 910-185P520 <u>FIRESTONE</u> 9297 <u>HENDRICKSON</u> 50898-1 50898-2 <u>TRIANGLE</u> 8520
1R12-403 Flexmember 566-24-3-097 Piston 566-20-7-246		ASA-92-8-203 		<u>Conti</u> 910-175P440 910-175P519 910-185P440 910-185P519 <u>FIRESTONE</u> 9373 <u>HENDRICKSON</u> 57122-1 <u>MCI</u> 2992101C1 <u>TRIANGLE</u> 8519
1R12-404 Flexmember 566-24-3-097 Piston 566-20-7-246		ASA-92-8-199 		<u>Conti</u> 910-175P451 910-185P451 <u>FIRESTONE</u> 9375 <u>HENDRICKSON</u> 50899-1 50899-2 <u>MACK TRUCK</u> 364SQ27 57QL414M <u>TRIANGLE</u> 8451
1R12-419 Flexmember 566-24-3-038 Piston 566-20-7-233		ASA-92-8-311 		

- Bolt or Stud 1/2-13 or 1/2-20
- Air Fitting - 1/4 NPTF
- Stud - 3/4-10
- Tapped Hole on Top Retainers 3/8-16, on Pistons - 1/2-13
- Air Fitting - 1/2 NPTF or 3/8 NPTF
- Combination Stud Air Fitting Stud - 3/4-16; Air Fitting - 1/4 NPTF

AIRSPRING ROLLING LOBES

Part No.	Side View With Extended And Compressed Height	Upper Mounting View	Lower Mounting View	Manufacturer Numbers
1R12-421 Flexmember 566-24-3-076 Piston 566-20-7-158	<p>18.0 7.0</p>	ASA-92-8-164 <p>5.50 9.00</p>	<p>7.87 9.80</p>	Conti 910-14P345 FIRESTONE 9010 REYCO 12928-01 RIDEWELL 1003589010C TRIANGLE 8345 WATSON & CHALIN AS-0044
1R12-422 Flexmember 566-24-3-076 Piston 566-20-7-036	<p>16.9 6.1</p>	ASA-92-8-013 <p>6.20 9.00</p>	<p>7.87 10.10</p>	NOVABUS N21361
1R12-423 Flexmember 566-24-3-038 Piston 566-20-7-246	<p>4.38 3.00 3.14 2.25 20.0 8.1</p>	ASA-92-8-199 <p>6.20 9.00</p>	M12x1.75-6g <p>10.13</p>	VOLVO 3180673
1R12-424 Flexmember 566-24-3-097 Piston 566-20-7-246	<p>7.75 5.98 3.64 2.36 20.0 8.1</p>	ASA-92-8-199 <p>6.20 9.00</p>	<p>4.50 10.13</p>	Conti 910-175P406 910-185P406 FIRESTONE 9287 HENDRICKSON 50405 50405-1 50405-2 TRIANGLE 8406
1R12-432 Flexmember 566-24-3-066 Piston 566-20-7-236	<p>4.38 3.95 2.99 23.0 6.7</p>	ASA-92-8-344 <p>5.87 9.00</p>	M12x1.75-6g <p>10.00</p>	Conti 910B-195P889 INT'L/ NAVISTAR 350243C94

- - Bolt or Stud 1/2-13 or 1/2-20
- ⊗ - Air Fitting - 1/4 NPTF
- - Stud - 3/4-10
- ⊙ - Tapped Hole on Top Retainers 3/8-16, on Pistons - 1/2-13
- ⊗ - Air Fitting - 1/2 NPTF or 3/8 NPTF
- ⊗ - Combination Stud Air Fitting Stud - 3/4-16; Air Fitting - 1/4 NPTF

Part No.	Side View With Extended And Compressed Height	Upper Mounting View	Lower Mounting View	Manufacturer Numbers
1R12-434 Flexmember 566-24-3-076 Piston 566-20-7-164		ASA-92-8-164 		<u>Conti</u> 910-14A469 910-14P469 <u>FIRESTONE</u> 8802 <u>NEWAY</u> 905-57-170 <u>RIDEWELL</u> 1003588802C <u>TRIANGLE</u> 8469
1R12-435 Flexmember 566-24-3-067 Piston 566-20-7-014		ASA-92-8-162 		<u>Conti</u> 910-10P471 910-10P482 <u>FIRESTONE</u> 9307 9334 <u>NEWAY</u> 905-57-129 <u>RIDEWELL</u> 1003589334C <u>TRIANGLE</u> 8471 8482
1R12-436 Flexmember 566-24-3-038 Piston 566-20-7-158		ASA-92-8-017 		<u>Conti</u> 910-16P497 <u>FIRESTONE</u> 8924 <u>RIDEWELL</u> 1003588924C <u>TRIANGLE</u> 8497
1R12-437 Flexmember 566-24-3-076 Piston 566-20-7-156		ASA-92-8-017 		<u>Conti</u> 910-14A496 <u>FIRESTONE</u> 9797 <u>RIDEWELL</u> 1003589797C <u>TRIANGLE</u> 8496
1R12-438 Flexmember 566-24-3-038 Piston 566-20-7-158		ASA-92-8-017 		<u>Conti</u> 910-14P462 <u>FIRESTONE</u> 8805 <u>RIDEWELL</u> 1003588805C <u>TRIANGLE</u> 8462

- - Bolt or Stud 1/2-13 or 1/2-20
- ⊗ - Air Fitting - 1/4 NPTF
- ⊙ - Stud - 3/4-10
- ⊗ (with top dot) - Tapped Hole on Top Retainers 3/8-16, on Pistons - 1/2-13
- ⊗ (with bottom dot) - Air Fitting - 1/2 NPTF or 3/8 NPTF
- ⊗ (with both dots) - Combination Stud Air Fitting Stud - 3/4-16; Air Fitting - 1/4 NPTF

AIRSPRING ROLLING LOBES

Part No.	Side View With Extended And Compressed Height	Upper Mounting View	Lower Mounting View	Manufacturer Numbers
1R12-439 Flexmember 566-24-3-066 Piston 566-20-7-237	<p>26.2 9.8</p>	ASA-92-8-164 <p>5.50 9.00</p>	<p>9.80</p>	Conti 910-19P470 FIRESTONE 9346 NEWAY 905-57-126 TRIANGLE 8470 WATSON & CHALIN AS-0056
1R12-441 Flexmember 566-24-3-038 Piston 566-20-7-235	<p>21.0 7.8</p>	ASA-92-8-164 <p>5.50 9.00</p>	<p>9.80</p>	Conti 910-16P391 FIRESTONE 9362 NEWAY 905-57-113 TRIANGLE 8391 WATSON & CHALIN AS-0049
1R12-444 Flexmember 566-24-3-066 Piston 566-20-7-159	<p>4.38 3.95 3.0 27.0 9.0</p>	ASA-92-8-004 <p>5.50 9.00</p>	<p>7.87 9.80</p>	
1R12-445 Flexmember 566-24-3-076 Piston 566-20-7-156	<p>17.0 5.5</p>	ASA-92-8-164 <p>5.50 9.00</p>	<p>7.87 9.80</p>	Conti 910-14A545 FIRESTONE 8806 RIDEWELL 1003588802X
1R12-446 Flexmember 566-24-3-097 Piston 566-20-7-158	<p>23.2 7.9</p>	ASA-92-8-164 <p>5.50 9.00</p>	<p>7.87 9.80</p>	Conti 910-19P390 FIRESTONE 9245 RIDEWELL 1003589245C TRIANGLE 8390

- Bolt or Stud 1/2-13 or 1/2-20
- Air Fitting - 1/4 NPTF
- Stud - 3/4-10
- Tapped Hole on Top Retainers 3/8-16, on Pistons - 1/2-13
- Air Fitting - 1/2 NPTF or 3/8 NPTF
- Combination Stud Air Fitting Stud - 3/4-16; Air Fitting - 1/4 NPTF

Part No.	Side View With Extended And Compressed Height	Upper Mounting View	Lower Mounting View	Manufacturer Numbers
1R12-450 Flexmember 566-24-3-097 Piston 566-20-7-158		ASA-92-8-164 		
1R12-454 Flexmember 566-24-3-038 Piston 566-20-7-079		ASA-92-8-283 		<u>MCI</u> 12L-1-215
1R12-462 Flexmember 566-24-3-038 Piston 566-20-7-246		ASA-92-8-199 	M12x1.75-6g 	<u>VOLVO</u> 3180984P2
1R12-465 Flexmember 566-24-3-067 Piston 566-20-7-014		ASA-92-8-013 		
1R12-467 Flexmember 566-24-3-066 Piston 566-20-7-005		ASA-92-8-331 		<u>Conti</u> 910-195P801 910-19A801 910-19A830 <u>RIDEWELL</u> 1000001

- - Bolt or Stud 1/2-13 or 1/2-20
- ⊗ - Air Fitting - 1/4 NPTF
- ⊙ - Stud - 3/4-10
- ⊕ - Tapped Hole on Top Retainers 3/8-16, on Pistons - 1/2-13
- ⊗ - Air Fitting - 1/2 NPTF or 3/8 NPTF
- ⊙ - Combination Stud Air Fitting Stud - 3/4-16; Air Fitting - 1/4 NPTF

AIRSPRING ROLLING LOBES

Part No.	Side View With Extended And Compressed Height	Upper Mounting View	Lower Mounting View	Manufacturer Numbers
1R12-480 Flexmember 566-24-3-066 Piston 566-20-7-235	<p>24.2 7.4</p>	ASA-92-8-164 <p>5.50 9.00</p>	<p>9.80</p>	Conti 910-19P384 FIRESTONE 9243 NEWAY 905-57-112 WATSON & CHALIN AS-0061
1R12-481 Flexmember 566-24-3-097 Piston 566-20-7-235	<p>23.4 7.4</p>	ASA-92-8-164 <p>5.50 9.00</p>	<p>9.80</p>	Conti 910-175P429 FIRESTONE 9923 NEWAY 905-57-118 TRIANGLE 8429
1R12-484 Flexmember 566-24-3-038 Piston 566-20-7-215	<p>6.52 4.00 3.64 2.21 20.7 10.5</p>	ASA-92-8-269 <p>5.87 9.00</p>	<p>7.87 9.80</p>	Conti 910-175P574 NEWAY 905-57-215
1R12-485 Flexmember 566-24-3-038 Piston 566-20-7-215	<p>20.7 9.9</p>	ASA-92-8-269 <p>5.87 9.00</p>	<p>7.87 9.80</p>	Conti 910-175P715 NEWAY 905-57-214
1R12-486 Flexmember 566-24-3-038 Piston 566-20-7-215	<p>20.7 10.5</p>	ASA-92-8-269 <p>5.87 9.00</p>	<p>7.87 9.80</p>	Conti 910-175P574 910-175P714 NEWAY 905-57-216

- Bolt or Stud 1/2-13 or 1/2-20
- Air Fitting - 1/4 NPTF
- Stud - 3/4-10
- Tapped Hole on Top Retainers 3/8-16, on Pistons - 1/2-13
- Air Fitting - 1/2 NPTF or 3/8 NPTF
- Combination Stud Air Fitting Stud - 3/4-16; Air Fitting - 1/4 NPTF

Part No.	Side View With Extended And Compressed Height	Upper Mounting View	Lower Mounting View	Manufacturer Numbers
1R12-487 Flexmember 566-24-3-067 Piston 566-20-7-239		ASA-92-8-164 		<u>Conti</u> 910-12A488 910-12P488 <u>FIRESTONE</u> 9366 <u>NEWAY</u> 905-57-160 905-57-210 905-57-225 <u>TRIANGLE</u> 8488 <u>WATSON & CHALIN</u> AS-0054
1R12-492 Flexmember 566-24-3-076 Piston 566-20-7-036		ASA-92-8-164 		
1R12-494 Flexmember 566-24-3-038 Piston 566-20-7-036		ASA-92-8-331 		<u>Conti</u> 910-175A802
1R12-498 Flexmember 566-24-3-097 Piston 566-20-7-237		ASA-92-8-164 		<u>Conti</u> 910-175P428 <u>FIRESTONE</u> 9922 <u>NEWAY</u> 905-57-119 <u>TRIANGLE</u> 8428
1R12-499 Flexmember 566-24-3-038 Piston 566-20-7-238		ASA-92-8-331 		<u>Conti</u> 910-175P454 <u>FIRESTONE</u> 9936 <u>NEWAY</u> 905-57-156 <u>TRIANGLE</u> 8454





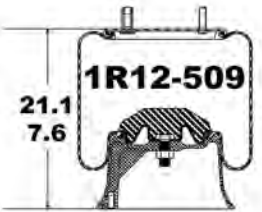
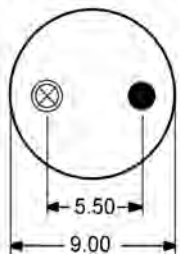
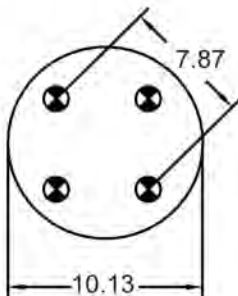
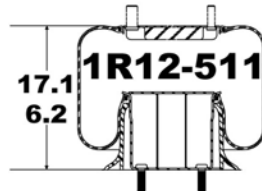
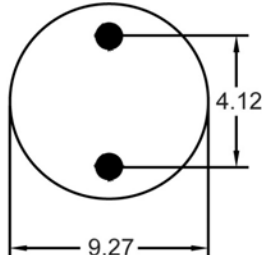
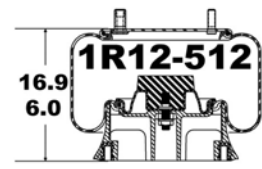
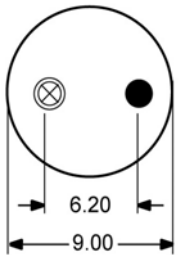
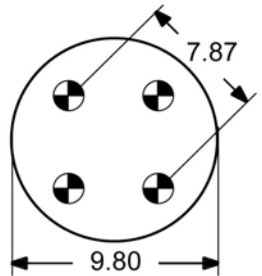
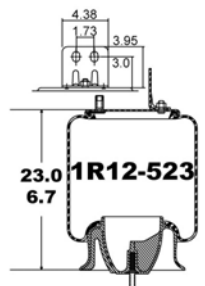
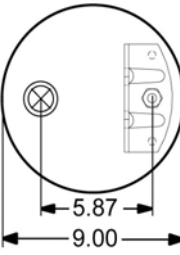
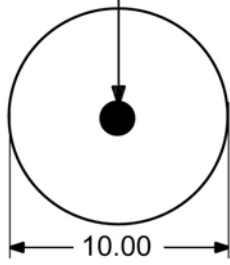

- - Bolt or Stud 1/2-13 or 1/2-20
- ⊕ - Tapped Hole on Top Retainers 3/8-16, on Pistons - 1/2-13
- ⊗ - Air Fitting - 1/4 NPTF
- ⊗ - Air Fitting - 1/2 NPTF or 3/8 NPTF
- - Stud - 3/4-10
- ⊗ - Combination Stud Air Fitting Stud - 3/4-16; Air Fitting - 1/4 NPTF

AIRSPRING ROLLING LOBES

Part No.	Side View With Extended And Compressed Height	Upper Mounting View	Lower Mounting View	Manufacturer Numbers
1R12-502 Flexmember 566-24-3-038 Piston 566-20-7-235		ASA-92-8-164 		Conti 910-175P443 FIRESTONE 9921 W013589921 NEWAY 905-57-117 TRIANGLE 8443 WATSON & CHALIN AS-0090
1R12-504 Flexmember 566-24-3-066 Piston 566-20-7-237		ASA-92-8-269 		Conti 910-175P502 FIRESTONE 9471
1R12-505 Flexmember 566-24-3-076 Piston 566-20-7-235		ASA-92-8-164 		Conti 910-12P395 FIRESTONE 9325 GILLIG 87-17289 NEWAY 905-57-149 TRIANGLE 8395
1R12-508 Flexmember 566-24-3-067 Piston 566-20-7-251		ASA-92-8-164 		Conti 910-12P484 FIRESTONE 8204 NEWAY 905-57-173 905-57-223 TRIANGLE 8484

- - Bolt or Stud 1/2-13 or 1/2-20
- ⊕ - Tapped Hole on Top Retainers 3/8-16, on Pistons - 1/2-13
- ⊗ - Air Fitting - 1/4 NPTF
- ⊗ - Air Fitting - 1/2 NPTF or 3/8 NPTF
- ⊙ - Stud - 3/4-10
- ⊗ - Combination Stud Air Fitting Stud - 3/4-16; Air Fitting - 1/4 NPTF

Part No.	Side View With Extended And Compressed Height	Upper Mounting View	Lower Mounting View	Manufacturer Numbers
1R12-509 Flexmember 566-24-3-038 Piston 566-20-7-005		ASA-92-8-164 		<u>Conti</u> 910-16P310 <u>DAYTON</u> 352-9082 <u>FAB TEK</u> 101828 <u>FIRESTONE</u> 9082 <u>GRANNING</u> 2727 <u>HDA</u> PMABG-9082B <u>HENDRICKSON</u> 36514-7 B-2066 <u>HUTCHENS</u> <u>IND.</u> 9630-01 <u>INT'L /</u> <u>NAVISTAR</u> 517559C9 <u>KWIK-LOK /</u> <u>TODCO</u> CP-3281 CP-5125 CP-5152 <u>LOAD GUARD</u> SC2035 <u>NEWAY</u> 905-57-006 905-57-027 905-57-037 905-57-054 905-57-075 <u>R & S TRUCK & BODY</u> 1090217 <u>REYCO</u> 12882-01 <u>RIDEWELL</u> 1003589082C S-542-C <u>SUSPENSIONS</u> <u>INC.</u> 201869 <u>TAURUS</u> AS506-9082 <u>TOYO</u> TRL-240/393 <u>TRIANGLE</u> 8310
1R12-511 Flexmember 566-24-3-048 Piston 566-20-7-240		UPPER BEAD PLATE NOT INCLUDED. SHOWN FOR REFERENCE ONLY.		<u>GMC</u> 15504181 G1015009 G1020956 <u>NOVABUS</u> G1015009 G1202944
1R12-512 Flexmember 566-24-3-076 Piston 566-20-7-156		ASA-92-8-005 		<u>Conti</u> 910-14A707 <u>FIRESTONE</u> 9127 <u>NEW FLYER</u> 9594
1R12-523 Flexmember 566-24-3-066 Piston 566-20-7-236		ASA-92-8-355 	M12x1.75-6g 	<u>INT'L /</u> <u>NAVISTAR</u> 3541732C1

-  - Bolt or Stud 1/2-13 or 1/2-20
-  - Air Fitting - 1/4 NPTF
-  - Stud - 3/4-10
-  - Tapped Hole on Top Retainers 3/8-16, on Pistons - 1/2-13
-  - Air Fitting - 1/2 NPTF or 3/8 NPTF
-  - Combination Stud Air Fitting Stud - 3/4-16; Air Fitting - 1/4 NPTF

AIRSPRING ROLLING LOBES

Part No.	Side View With Extended And Compressed Height	Upper Mounting View	Lower Mounting View	Manufacturer Numbers
1R12-527 Flexmember 566-24-3-066 Piston 566-20-7-006		ASA-92-8-002 		
1R12-530 Flexmember 566-24-3-061 Piston 566-20-7-251		ASA-92-8-164 		FIRESTONE 9306
1R12-531 Flexmember 566-24-3-061 Piston 566-20-7-251		ASA-92-8-164 		
1R12-532 Flexmember 566-24-3-097 Piston 566-20-7-235		ASA-92-8-331 		Conti 910-175P548 FIRESTONE 9935 NEWAY 905-57-157 TRIANGLE 8548
1R12-534 Flexmember 566-24-3-116 Piston 566-20-7-158		ASA-92-8-360 		Conti 910-19P762

- - Bolt or Stud 1/2-13 or 1/2-20
- ⊗ - Air Fitting - 1/4 NPTF
- - Stud - 3/4-10
- ⊙ - Tapped Hole on Top Retainers 3/8-16, on Pistons - 1/2-13
- ⊗ - Air Fitting - 1/2 NPTF or 3/8 NPTF
- ⊗ - Combination Stud Air Fitting Stud - 3/4-16; Air Fitting - 1/4 NPTF

Part No.	Side View With Extended And Compressed Height	Upper Mounting View	Lower Mounting View	Manufacturer Numbers
1R12-538 Flexmember 566-24-3-038 Piston 566-20-7-236		ASA-92-8-165 	M12 x 1.75-6G 	<u>Conti</u> 910-175P456 910-185P456 <u>FIRESTONE</u> 9648 <u>INT'L /</u> <u>NAVISTAR</u> 2027911C1 2027911C2 2027911C3 <u>TRIANGLE</u> 8456
1R12-541 Flexmember 566-24-3-038 Piston 566-20-7-209		ASA-92-8-360 		<u>Conti</u> 910-16P769 <u>WATSON &</u> <u>CHALIN</u> AS-0113G
1R12-543 Flexmember 566-24-3-076 Piston 566-20-7-212		ASA-92-8-269 		<u>Conti</u> 910-14AT75 <u>NEWAY</u> 905-57-275
1R12-552 Flexmember 566-24-3-038 Piston 566-20-7-215		ASA-92-8-269 		<u>Conti</u> 910-175P572 <u>FIRESTONE</u> 9471 <u>NEWAY</u> 905-57-212
1R12-553 Flexmember 566-24-3-038 Piston 566-20-7-213		ASA-92-8-269 		<u>Conti</u> 910-175P573 <u>FIRESTONE</u> 9472 9491 <u>NEWAY</u> 905-57-213 <u>TRIANGLE</u> 8467

- Bolt or Stud 1/2-13 or 1/2-20
- Air Fitting - 1/4 NPTF
- Stud - 3/4-10
- Tapped Hole on Top Retainers 3/8-16, on Pistons - 1/2-13
- Air Fitting - 1/2 NPTF or 3/8 NPTF
- Combination Stud Air Fitting Stud - 3/4-16; Air Fitting - 1/4 NPTF

AIRSPRING ROLLING LOBES

Part No.	Side View With Extended And Compressed Height	Upper Mounting View	Lower Mounting View	Manufacturer Numbers
1R12-554 Flexmember 566-24-3-038 Piston 566-20-7-214		ASA-92-8-269 		Conti 910-175P571 FIRESTONE 9470 NEWAY 905-57-211 TRIANGLE 8501
1R12-555 Flexmember 566-24-3-067 Piston 566-20-7-253		ASA-92-8-017 		Conti 910-10P542 FIRESTONE 8961 REYCO 23377-01 TRIANGLE 8542
1R12-556 Flexmember 566-24-3-067 Piston 566-20-7-252		ASA-92-8-017 		Conti 910-10P480 FIRESTONE 8964 REYCO 21598-01 TRIANGLE 8480
1R12-557 Flexmember 566-24-3-067 Piston 566-20-7-252		ASA-92-8-017 		Conti 910-10P503 FIRESTONE 8976 REYCO 21055-01 TRIANGLE 8503
1R12-558 Flexmember 566-24-3-067 Piston 566-20-7-252		ASA-92-8-164 		Conti 910-10P400 FIRESTONE 8986 RIDEWELL 1003588986C TRIANGLE 8400

- - Bolt or Stud 1/2-13 or 1/2-20
- ⊗ - Air Fitting - 1/4 NPTF
- ⊙ - Stud - 3/4-10
- ⊕ - Tapped Hole on Top Retainers 3/8-16, on Pistons - 1/2-13
- ⊗ - Air Fitting - 1/2 NPTF or 3/8 NPTF
- ⊙ - Combination Stud Air Fitting Stud - 3/4-16; Air Fitting - 1/4 NPTF

Part No.	Side View With Extended And Compressed Height	Upper Mounting View	Lower Mounting View	Manufacturer Numbers
1R12-559 Flexmember 566-24-3-067 Piston 566-20-7-252		ASA-92-8-164 		<u>Conti</u> 910-10P399 <u>FIRESTONE</u> 9029 <u>RIDEWELL</u> 1003589029C <u>TRIANGLE</u> 8399
1R12-560 Flexmember 566-24-3-067 Piston 566-20-7-253		ASA-92-8-164 		<u>Conti</u> 910-10P398 <u>FIRESTONE</u> 9308 <u>NEWAY</u> 905-57-089 <u>REYCO</u> 17360-01 <u>TRIANGLE</u> 8398
1R12-561 Flexmember 566-24-3-067 Piston 566-20-7-253		ASA-92-8-164 		<u>Conti</u> 910-10P397 <u>FIRESTONE</u> 9332 <u>REYCO</u> 20074-01 <u>TRIANGLE</u> 8397
1R12-562 Flexmember 566-24-3-067 Piston 566-20-7-251		ASA-92-8-331 		<u>FIRESTONE</u> 8197 <u>NEWAY</u> 905-57-230
1R12-563 Flexmember 566-24-3-067 Piston 566-20-7-252		ASA-92-8-192 		<u>Conti</u> 910-12P544 <u>FIRESTONE</u> 8934 <u>HENDRICKSON</u> S-20228 <u>TRIANGLE</u> 8544

- - Bolt or Stud 1/2-13 or 1/2-20
- ⊗ - Air Fitting - 1/4 NPTF
- - Stud - 3/4-10
- ⊕ - Tapped Hole on Top Retainers 3/8-16, on Pistons - 1/2-13
- ⊗ - Air Fitting - 1/2 NPTF or 3/8 NPTF
- ⊗ - Combination Stud Air Fitting Stud - 3/4-16; Air Fitting - 1/4 NPTF

AIRSPRING ROLLING LOBES

Part No.	Side View With Extended And Compressed Height	Upper Mounting View	Lower Mounting View	Manufacturer Numbers
1R12-567 Flexmember 566-24-3-038 Piston 566-20-7-235	<p>21.0 6.7</p>	ASA-92-8-041 <p>2.88 6.20 9.00</p>	<p>9.80</p>	Conti 910-16P393 FIRESTONE 9026 PETERBILT 03-06213 03-07111 TRIANGLE 8393
1R12-568 Flexmember 566-24-3-066 Piston 566-20-7-235	<p>24.7 6.7</p>	ASA-92-8-041 <p>2.88 6.20 9.00</p>	<p>9.80</p>	Conti 910-19P472 FIRESTONE 8852 PETERBILT 03-07887 TRIANGLE 8472
1R12-571 Flexmember 566-24-3-067 Piston 566-20-7-238	<p>16.0 6.5</p>	ASA-92-8-164 <p>5.50 9.00</p>	<p>9.80</p>	Conti 910-12P495 FIRESTONE 9365 NEWAY 905-57-159 TRIANGLE 8495
1R12-576 Flexmember 566-24-3-038 Piston 566-20-7-159	<p>22.8 9.5</p>	ASA-92-8-005 <p>6.20 9.00</p>	<p>7.87 9.80</p>	Conti 910-16P770
1R12-580 Flexmember 566-24-3-117 Piston 566-20-7-299	<p>28.2 9.5</p>	ASA-92-8-367 <p>6.20 10.30</p>	<p>10.6</p>	Conti 910-21P448 FIRESTONE 9370 WATSON & CHALIN AS-0057





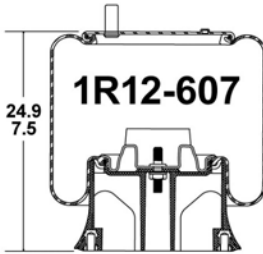
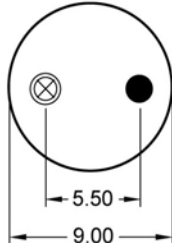
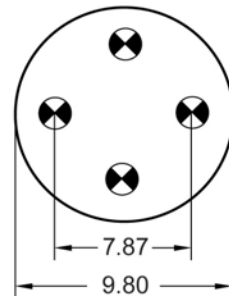
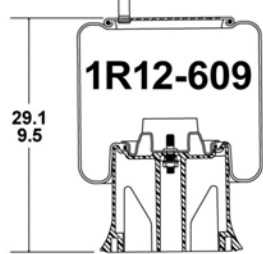
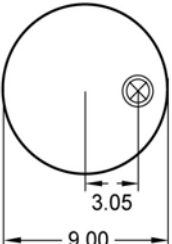
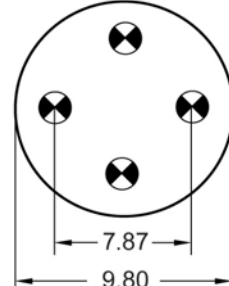
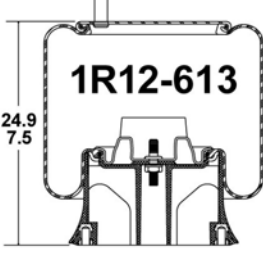
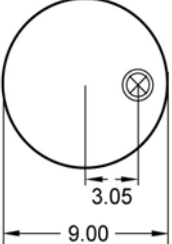
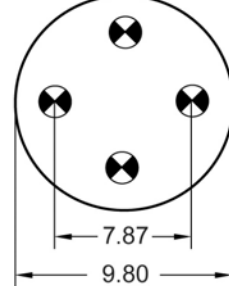
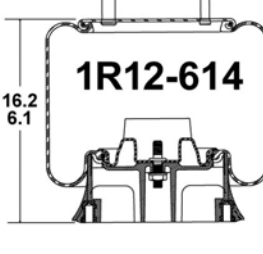
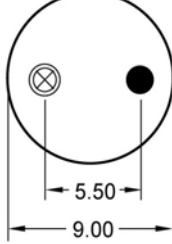
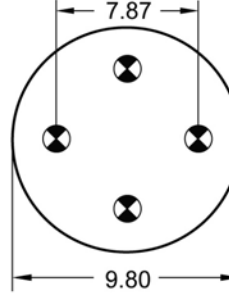
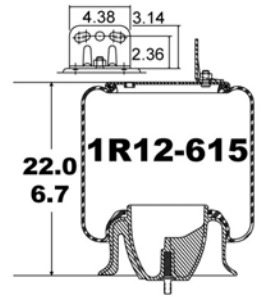
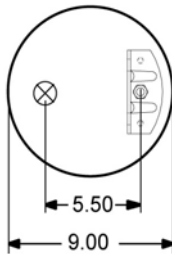
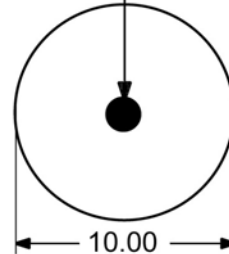

- - Bolt or Stud 1/2-13 or 1/2-20
- ⊗ - Air Fitting - 1/4 NPTF
- - Stud - 3/4-10
- ⊙ - Tapped Hole on Top Retainers 3/8-16, on Pistons - 1/2-13
- ⊗ - Air Fitting - 1/2 NPTF or 3/8 NPTF
- ⊗ - Combination Stud Air Fitting Stud - 3/4-16; Air Fitting - 1/4 NPTF

Part No.	Side View With Extended And Compressed Height	Upper Mounting View	Lower Mounting View	Manufacturer Numbers
1R12-584 Flexmember 566-24-3-038 Piston 566-20-7-158		ASA-92-8-331 		<u>RIDEWELL</u> 1001R12584G
1R12-586 Flexmember 566-24-3-038 Piston 566-20-7-237		ASA-92-8-269 		<u>Conti</u> 910-175P445 <u>FIRESTONE</u> 9473 <u>NEWAY</u> 905-57-152 905-57-179
1R12-599 Flexmember 566-24-3-090 Piston 566-20-7-159		ASA-92-8-331 		
1R12-600 Flexmember 566-24-3-076 Piston 566-20-7-156		ASA-92-8-331 		
1R12-603 Flexmember 566-24-3-108 Piston 566-20-7-322		ASA-92-8-440 		<u>Conti</u> 910S-16A382 <u>FIRESTONE</u> 9780 9781 <u>FREIGHTLINER</u> 6813200017 A16-14004-000 A16-14004-001 <u>TRIANGLE</u> 8382

- Bolt or Stud 1/2-13 or 1/2-20
- Air Fitting - 1/4 NPTF
- Stud - 3/4-10
- Tapped Hole on Top Retainers 3/8-16, on Pistons - 1/2-13
- Air Fitting - 1/2 NPTF or 3/8 NPTF
- Combination Stud Air Fitting Stud - 3/4-16; Air Fitting - 1/4 NPTF

AIRSPRING ROLLING LOBES

Part No.	Side View With Extended And Compressed Height	Upper Mounting View	Lower Mounting View	Manufacturer Numbers
1R12-607 Flexmember 566-24-3-066 Piston 566-20-7-158	 <p>24.9 7.5</p>	ASA-92-8-331  <p>5.50 9.00</p>	 <p>7.87 9.80</p>	
1R12-609 Flexmember 566-24-3-090 Piston 566-20-7-159	 <p>29.1 9.5</p>	ASA-92-8-192  <p>3.05 9.00</p>	 <p>7.87 9.80</p>	Conti 910-21P817
1R12-613 Flexmember 566-24-3-066 Piston 566-20-7-158	 <p>24.9 7.5</p>	ASA-92-8-192  <p>3.05 9.00</p>	 <p>7.87 9.80</p>	Conti 910-19A552
1R12-614 Flexmember 566-24-3-076 Piston 566-20-7-156	 <p>16.2 6.1</p>	ASA-92-8-164  <p>5.50 9.00</p>	 <p>7.87 9.80</p>	
1R12-615 Flexmember 566-25-3-097 Piston 566-20-7-303	 <p>4.38 3.14 2.36 22.0 6.7</p>	ASA-92-8-306  <p>5.50 9.00</p>	M12x1.75-6g  <p>10.00</p>	Conti 910-16P449 FIRESTONE 8829 TRIANGLE 8449 VOLVO 20396293 20413888 20505399 3934699 8079902 8084296 8097092

-  - Bolt or Stud 1/2-13 or 1/2-20
-  - Tapped Hole on Top Retainers 3/8-16, on Pistons - 1/2-13
-  - Air Fitting - 1/4 NPTF
-  - Air Fitting - 1/2 NPTF or 3/8 NPTF
-  - Stud - 3/4-10
-  - Combination Stud Air Fitting Stud - 3/4-16; Air Fitting - 1/4 NPTF

Part No.	Side View With Extended And Compressed Height	Upper Mounting View	Lower Mounting View	Manufacturer Numbers
1R12-616 Flexmember 566-24-3-076 Piston 566-20-7-251		ASA-92-8-164 		
1R12-617 Flexmember 566-24-3-038 Piston 566-20-7-036		ASA-92-8-164 		
1R12-620 Flexmember 566-24-3-076 Piston 566-20-7-239		ASA-92-8-430 		Conti 910-14P465 FIRESTONE 9335 HENDRICKSON 56917-1 56917-2 TRIANGLE 8465
1R12-621 Flexmember 566-24-3-097 Piston 566-20-7-159		ASA-92-8-164 		Conti 910-16P332 FIRESTONE 9093 NEWAY 905-57-007 905-57-032 905-57-035 TRIANGLE 8332
1R12-622 Flexmember 566-24-3-097 Piston 566-20-7-236		ASA-92-8-355 	M12 X 1.75-6g 	INT'L / NAVISTAR 3596112C1

- - Bolt or Stud 1/2-13 or 1/2-20
- ⊗ - Air Fitting - 1/4 NPTF
- - Stud - 3/4-10
- ⊙ - Tapped Hole on Top Retainers 3/8-16, on Pistons - 1/2-13
- ⊗ - Air Fitting - 1/2 NPTF or 3/8 NPTF
- ⊗ - Combination Stud Air Fitting Stud - 3/4-16; Air Fitting - 1/4 NPTF

AIRSPRING ROLLING LOBES

Part No.	Side View With Extended And Compressed Height	Upper Mounting View	Lower Mounting View	Manufacturer Numbers
1R12-631 Flexmember 566-24-3-120 Piston 566-20-7-079	<p>22.8 8.1</p> <p>1R12-631</p>	ASA-92-8-439 1.250-12 UNF outside .500-14 NPTF inside <p>5.75 9.00</p>	<p>4.12 10.2</p>	PREVOST 63-0125
1R12-636 Flexmember 566-24-3-076 Piston 566-20-7-156	<p>17.1 5.3</p> <p>1R12-636</p> <p>2.00</p>	ASA-92-8-440 <p>6.20 9.00</p>	<p>7.87 9.80</p>	Conti 910-14A575 FIRESTONE 9634
1R12-637 Flexmember 566-24-3-090 Piston 566-20-7-159	<p>29.1 8.3</p> <p>1R12-637</p>	ASA-92-8-164 <p>5.50 9.00</p>	<p>7.87 9.80</p>	
1R12-639 Flexmember 566-24-3-066 Piston 566-20-7-159	<p>26.2 9.5</p> <p>1R12-639</p>	ASA-92-8-164 <p>5.50 9.00</p>	<p>7.87 9.80</p>	
1R12-640 Flexmember 566-24-3-038 Piston 566-20-7-238	<p>18.8 6.7</p> <p>1R12-640</p>	ASA-92-8-257 <p>1.50 4.75 9.00</p>	<p>9.80</p>	

- - Bolt or Stud 1/2-13 or 1/2-20
- ⊗ - Air Fitting - 1/4 NPTF
- - Stud - 3/4-10
- ⊙ - Tapped Hole on Top Retainers 3/8-16, on Pistons - 1/2-13
- ⊗ - Air Fitting - 1/2 NPTF or 3/8 NPTF
- ⊗ - Combination Stud Air Fitting Stud - 3/4-16; Air Fitting - 1/4 NPTF





Part No.	Side View With Extended And Compressed Height	Upper Mounting View	Lower Mounting View	Manufacturer Numbers
1R12-644 Flexmember 566-24-3-097 Piston 566-20-7-158	<p>23.2 7.0</p> <p>1R12-644</p>	AS1-92-8-192 <p>3.05 9.00</p>	<p>7.87 9.80</p>	
1R12-647 Flexmember 566-24-3-097 Piston 566-20-7-303	<p>22.0 6.7</p> <p>1R12-647</p>	ASA-92-8-306 <p>5.50 9.00</p>	M12x1.75-6g <p>10.00</p>	
1R12-648 Flexmember 566-24-3-076 Piston 566-20-7-239	<p>16.9 6.0</p> <p>1R12-648</p>	ASA-92-8-164 <p>5.50 9.00</p>	<p>9.80</p>	FIRESTONE 9336
1R12-653 Flexmember 566-24-3-066 Piston 566-20-7-159	<p>26.3 9.0</p> <p>1R12-653</p>	ASA-92-8-004 <p>5.50 9.00</p>	<p>7.87 9.80</p>	
1R12-655 Flexmember 566-24-3-076 Piston 566-20-7-158	<p>18.0 7.5</p> <p>1R12-655</p>	ASA-92-8-164 <p>5.50 9.00</p>	<p>7.87 9.80</p>	





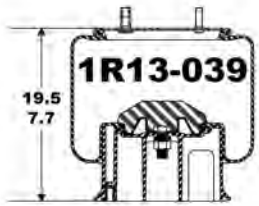
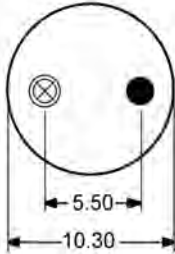
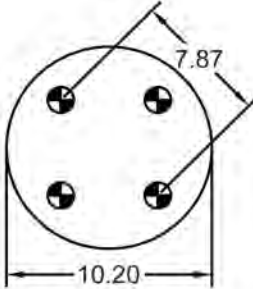
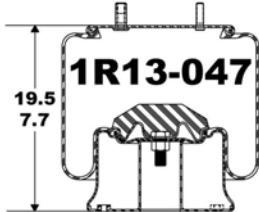
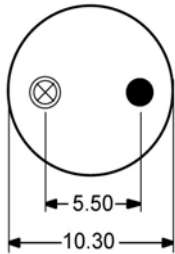
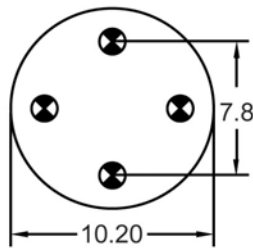

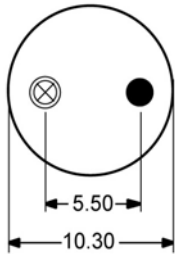
- Bolt or Stud 1/2-13 or 1/2-20
- Air Fitting - 1/4 NPTF
- Stud - 3/4-10
- Tapped Hole on Top Retainers 3/8-16, on Pistons - 1/2-13
- Air Fitting - 1/2 NPTF or 3/8 NPTF
- Combination Stud Air Fitting Stud - 3/4-16; Air Fitting - 1/4 NPTF

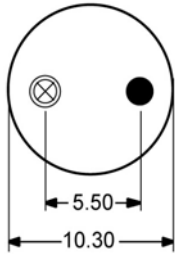
AIRSPRING ROLLING LOBES

Part No.	Side View With Extended And Compressed Height	Upper Mounting View	Lower Mounting View	Manufacturer Numbers
1R12-669 Flexmember 566-24-3-038 Piston 566-20-7-053	<p>21.1 7.5</p>	ASA-92-8-021 <p>2.88 6.20 9.00</p>	<p>9.3</p>	Conti 910-14P312 DAYTON 352-9069 FIRESTONE 9069 INT'L/NAVISTAR 554764C1 LOAD GUARD SC2034 PETERBILT 03-01649 03-02038 03-02456 03-04759 03-07112 23-10042 TAURUS AS504-9069 TRIANGLE 8312 WATSON & CHALIN AS-0077
1R12-676 Flexmember 566-24-3-076 Piston 566-20-7-235	<p>18.0 7.5</p>	ASA-92-8-041 <p>2.88 6.20 9.00</p>	<p>9.80</p>	
1R12-689 Flexmember 566-24-3-066 Piston 566-20-7-236	<p>4.38 4.0 3.0 23.0 6.7</p>	ASA-92-8-344 <p>5.87 9.00</p>	M12 X 1.75-6g <p>10.00</p>	
1R13-038 Flexmember 566-26-3-072 Piston 566-20-7-097	<p>24.9 8.9</p>	ASA-92-8-245 <p>5.50 10.30</p>	<p>7.87 10.20</p>	Conti 11105-21A313 DAYTON 905-57-077 352-9122 905-57-077 HENDRICKSON AR-1215-1-G B-12514-008 REYCO B-3830 12883-02 C-22173 RIDEWELL S-3467 1003589122C S-3830 S-3053-C INT'L/NAVISTAR TAURUS 554772C1 AS622-9122 LOAD GUARD TOYO SC2041 TRL-270/476 NEWAY WATSON & 905-57-020 CHALIN AS-0023

- Bolt or Stud 1/2-13 or 1/2-20
- Tapped Hole on Top Retainers 3/8-16, on Pistons - 1/2-13
- Air Fitting - 1/4 NPTF
- Air Fitting - 1/2 NPTF or 3/8 NPTF
- Stud - 3/4-10
- Combination Stud Air Fitting Stud - 3/4-16; Air Fitting - 1/4 NPTF

Part No.	Side View With Extended And Compressed Height	Upper Mounting View	Lower Mounting View	Manufacturer Numbers
<p>1R13-039</p> <p>Flexmember 566-26-3-051</p> <p>Piston 566-20-7-327</p>		<p>ASA-92-8-245</p> 		<p><u>Conti</u> 1010-165S783 <u>DAYTON</u> 352-9121 <u>FIRESTONE</u> 9121 <u>HDA</u> PMABG-9123B <u>HENDRICKSON</u> B-3411 <u>INT'L / NAVISTAR</u> 554773C1 <u>LOAD GUARD</u> SC2040 <u>NEWAY</u> 905-57-019 905-57-052 905-57-078 905-57-083 AR-1115-1-G</p> <p><u>R & S TRUCK & BODY</u> 1090023 <u>REYCO</u> 12882-02 <u>RIDEWELL</u> 1003589121C S-3052-C <u>SAUR AXLES (SAS)</u> P50-733B <u>TAURUS</u> AS621-9121 <u>TRIANGLE</u> 8317 <u>WATSON & CHALIN</u> AS-0013 AS-0083</p>
<p>1R13-047</p> <p>Flexmember 566-26-3-051</p> <p>Piston 566-20-7-096</p>		<p>ASA-92-8-245</p> 		<p><u>NEWAY</u> 905-57-110 <u>TRIANGLE</u> 8377</p>
<p>1R13-048</p> <p>Flexmember 566-26-3-072</p> <p>Piston Not Included</p>		<p>ASA-92-8-245</p> 	<p>USE EXISTING GOODYEAR ENGINEERED PRODUCTS PISTON</p>	<p><u>INT'L / NAVISTAR</u> 554774C1 <u>LOAD GUARD</u> SC2056 <u>NEWAY</u> 900-44-658 900-44-668 <u>RIDEWELL</u> 1013589124C <u>TAURUS</u> AS622-9124</p>
<p>1R13-049</p> <p>Flexmember 566-26-3-051</p> <p>Piston Not Included</p>		<p>ASA-92-8-245</p> 	<p>USE EXISTING GOODYEAR ENGINEERED PRODUCTS PISTON</p>	<p><u>INT'L / NAVISTAR</u> 554775C1 <u>LOAD GUARD</u> SC2055 <u>NEWAY</u> 900-44-670 900-44-702 905-54-060 <u>RIDEWELL</u> 1013589123C <u>TAURUS</u> AS621-9123</p>

-  - Bolt or Stud 1/2-13 or 1/2-20
-  - Air Fitting - 1/4 NPTF
-  - Stud - 3/4-10
-  - Tapped Hole on Top Retainers 3/8-16, on Pistons - 1/2-13
-  - Air Fitting - 1/2 NPTF or 3/8 NPTF
-  - Combination Stud Air Fitting Stud - 3/4-16; Air Fitting - 1/4 NPTF

AIRSPRING ROLLING LOBES

Part No.	Side View With Extended And Compressed Height	Upper Mounting View	Lower Mounting View	Manufacturer Numbers
1R13-053 Flexmember 566-26-3-051 Piston 566-20-7-036		ASA-20-8-245 		FIRESTONE 8754 NEW FLYER 13
1R13-070 Flexmember 566-26-3-015 Piston 566-20-7-084		ASD-20-8-053 	3/4-10 	Conti 910-19P444 LOAD GUARD SC2776 MACK TRUCK 57QL332 57QL39306 NEWAY 905-44-608 905-57-070 905-57-087 TRIANGLE 8444
1R13-075 Flexmember 566-26-3-051 Piston 566-20-7-036-03		ASA-92-8-245 		
1R13-097 Flexmember 566-26-3-081 Piston 566-20-7-296		ASA-92-8-245 		Conti 1010-15S518 RIDEWELL 1001R13-087 1001R13-097 1003588752C TRIANGLE 8518
1R13-109 Flexmember 566-26-3-081 Piston 566-20-7-296		ASA-92-8-243 		Conti 1010-15S871 FIRESTONE 8782 RIDEWELL 1001R13-109

- - Bolt or Stud 1/2-13 or 1/2-20
- ⊗ - Air Fitting - 1/4 NPTF
- - Stud - 3/4-10
- ⊕ - Tapped Hole on Top Retainers 3/8-16, on Pistons - 1/2-13
- ⊗ - Air Fitting - 1/2 NPTF or 3/8 NPTF
- ⊗ - Combination Stud Air Fitting Stud - 3/4-16; Air Fitting - 1/4 NPTF

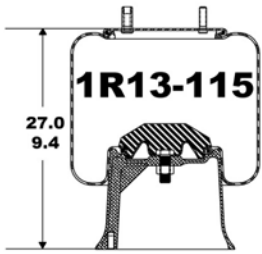
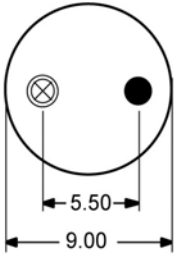
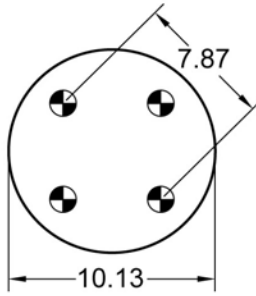
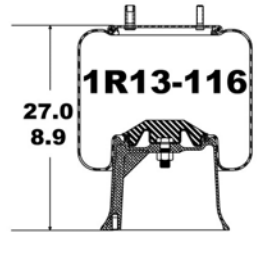
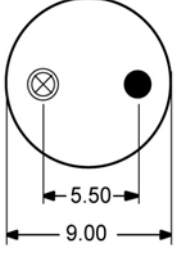
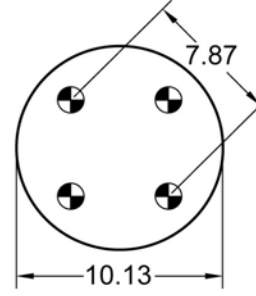
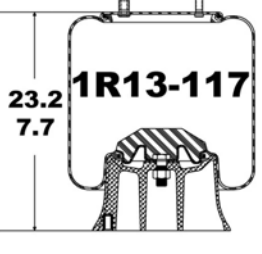
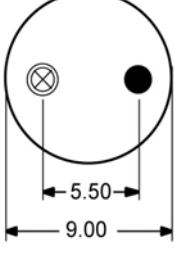
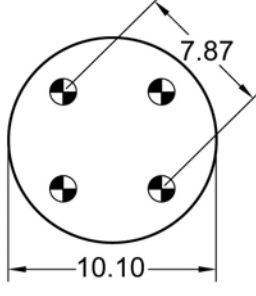
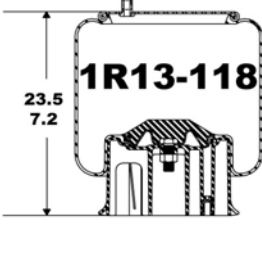
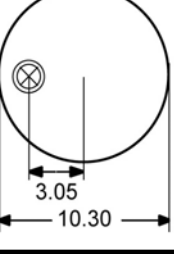
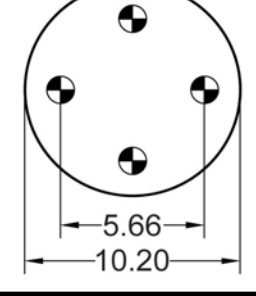
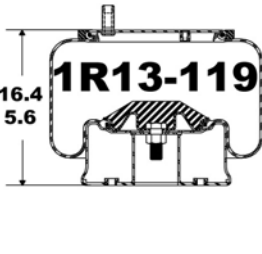
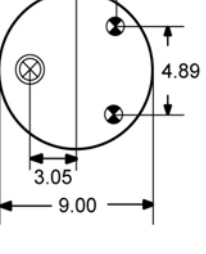
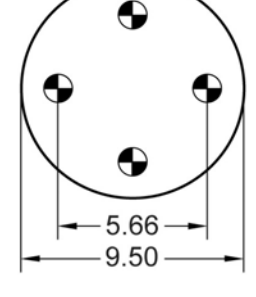
Part No.	Side View With Extended And Compressed Height	Upper Mounting View	Lower Mounting View	Manufacturer Numbers
1R13-115 Flexmember 566-26-3-044 Piston 566-20-7-006		ASA-92-8-004 		<u>Conti</u> 910D-21A324 <u>FIRESTONE</u> 9250 <u>RIDEWELL</u> 1003589250C <u>TRIANGLE</u> 8324 <u>WATSON & CHALIN</u> AS-0096
1R13-116 Flexmember 566-26-3-044 Piston 566-20-7-006		ASA-92-8-004 		<u>Conti</u> 910D-21A363 <u>FIRESTONE</u> 9252 <u>RIDEWELL</u> 1003589252C <u>TRIANGLE</u> 8363
1R13-117 Flexmember 566-26-3-043 Piston 566-20-7-080		ASA-92-8-004 		<u>Conti</u> 910B-175A323 <u>FIRESTONE</u> 9275 <u>RIDEWELL</u> 1003589275C <u>TRIANGLE</u> 8323
1R13-118 Flexmember 566-26-3-068 Piston 566-20-7-325		ASA-92-8-240 		<u>Conti</u> 1010-21P434 <u>FIRESTONE</u> 9262 9580 W013589580 <u>HENDRICKSON</u> C-20127 C-20414 <u>TRIANGLE</u> 8434
1R13-119 Flexmember 566-26-3-053 Piston 566-20-7-106		ASA-92-8-235 		<u>Conti</u> 910-135S433 910-135S881 <u>FIRESTONE</u> 9270 W013589270 <u>HENDRICKSON</u> 1R13-102 C-20010 C-21208 S-25559 <u>TRIANGLE</u> 8433 <u>WATSON & CHALIN</u> AS-0084

- - Bolt or Stud 1/2-13 or 1/2-20
- ⊗ - Air Fitting - 1/4 NPTF
- - Stud - 3/4-10
- ⊙ - Tapped Hole on Top Retainers 3/8-16, on Pistons - 1/2-13
- ⊗ - Air Fitting - 1/2 NPTF or 3/8 NPTF
- ⊗ - Combination Stud Air Fitting Stud - 3/4-16; Air Fitting - 1/4 NPTF

AIRSPRING ROLLING LOBES

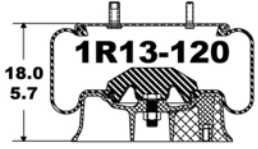
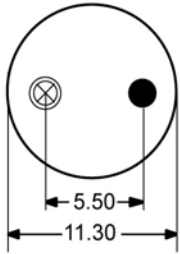
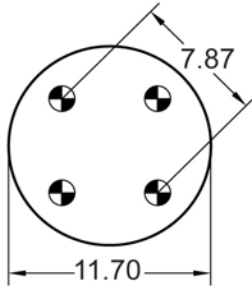
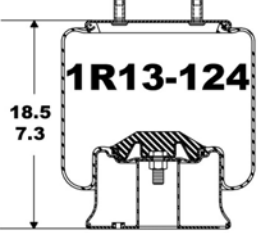
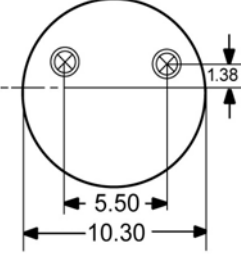
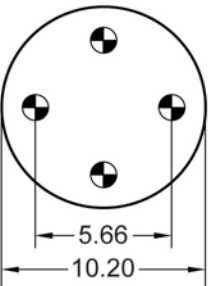
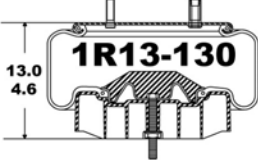
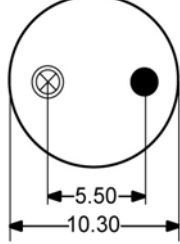
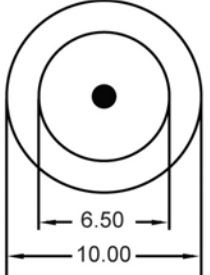
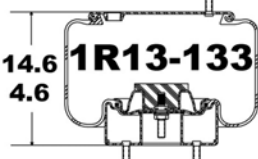
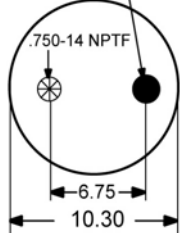
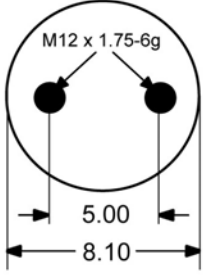
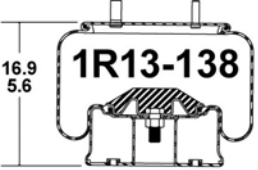
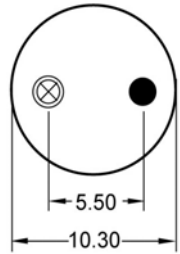
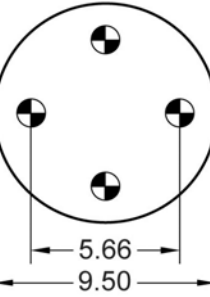

Part No.	Side View With Extended And Compressed Height	Upper Mounting View	Lower Mounting View	Manufacturer Numbers
1R13-120 Flexmember 566-26-3-054 Piston 566-20-7-334		ASA-92-8-049 		Conti 11105-15A422 FIRESTONE 9218 NEWAY 905-57-209 RIDEWELL 1003589218C TRIANGLE 8422 WATSON & CHALIN AS-0073
1R13-124 Flexmember 566-26-3-050 Piston 566-20-7-127		ASA-92-8-230 		Conti 1010-15S522 1010-15S711 FIRESTONE 8710 8755 W013588755 HENDRICKSON B-22046 C-21623 C-22045 C-22046 TRIANGLE 8522
1R13-130 Flexmember 566-26-3-055 Piston 566-20-7-230		ASA-92-8-245 		Conti 1010B-13S513 FIRESTONE 8729 MERITOR 202796 SUSPENSIONS INC. 202796 TRIANGLE 8513
1R13-133 Flexmember 566-26-3-056 Piston 566-20-7-231		ASA-92-8-307 M12x1.75-6G 		DINA 224-B020018 MCI 1510979
1R13-138 Flexmember 566-26-3-050 Piston 566-20-7-106		ASA-92-8-245 		FIRESTONE 8752





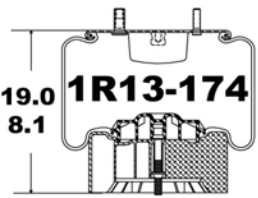
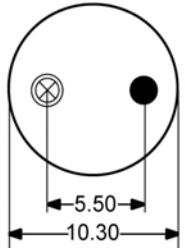
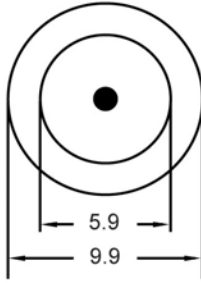
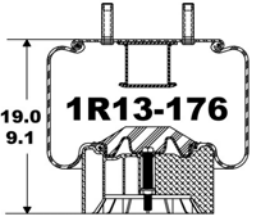
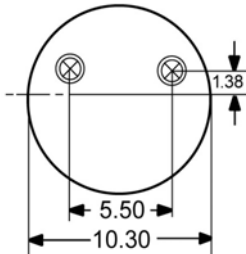
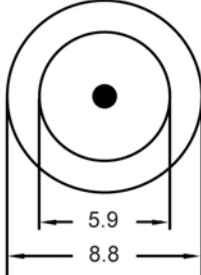
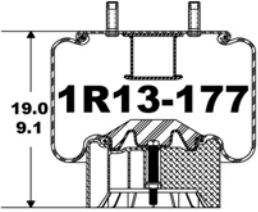
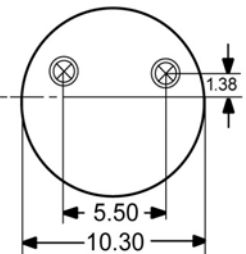
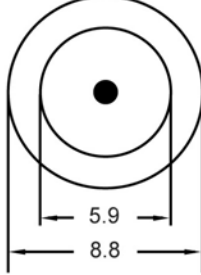
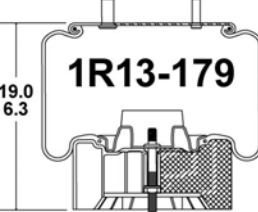
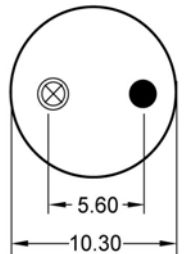

- - Bolt or Stud 1/2-13 or 1/2-20
- ⊗ - Air Fitting - 1/4 NPTF
- - Stud - 3/4-10
- ⊗ - Tapped Hole on Top Retainers 3/8-16, on Pistons - 1/2-13
- ⊗ - Air Fitting - 1/2 NPTF or 3/8 NPTF
- ⊗ - Combination Stud Air Fitting Stud - 3/4-16; Air Fitting - 1/4 NPTF

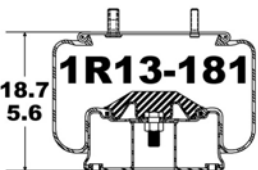
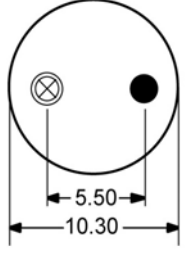
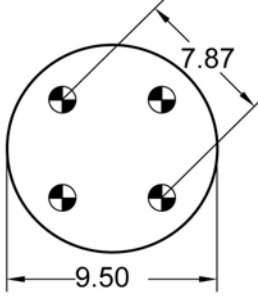
Part No.	Side View With Extended And Compressed Height	Upper Mounting View	Lower Mounting View	Manufacturer Numbers
1R13-151 Flexmember 566-26-3-069 Piston 566-20-7-334	<p>13.9 5.1</p>	ASA-92-8-326 <p>3.12 6.25 11.30</p>	<p>7.87 11.70</p>	
1R13-152 Flexmember 566-26-3-071 Piston 566-20-7-235	<p>21.4 7.5</p>	ASA-92-8-245 <p>5.50 10.30</p>	<p>9.80</p>	Conti 1010-21P570 FIRESTONE 8748 NEWAY 905-57-167 AR-250-14 AR-250-15
1R13-153 Flexmember 566-26-3-071 Piston 566-20-7-237	<p>23.5 9.0</p>	ASA-92-8-245 <p>5.50 10.30</p>	<p>9.80</p>	Conti 1010-21P486 FIRESTONE 8749 NEWAY 905-57-168 AR-250-12 AR-250-16 AR-250-17 TRIANGLE 8486
1R13-155 Flexmember 566-26-3-051 Piston 566-20-7-106	<p>18.7 5.6</p>	ASA-92-8-243 <p>2.13 6.20 10.30</p>	<p>5.66 9.50</p>	Conti 1010-16S724 WATSON & CHALIN AS-0107G
1R13-159 Flexmember 566-26-3-073 Piston 566-20-7-154	<p>18.0 6.1</p>	ASA-92-8-230 <p>1.38 5.50 10.30</p>	<p>5.9 8.8</p>	Conti 1010-15P453 10105-15P460 FIRESTONE 8709 8751 HENDRICKSON C-20900 C-21800 TRIANGLE 8460

- - Bolt or Stud 1/2-13 or 1/2-20
- ⊗ - Air Fitting - 1/4 NPTF
- - Stud - 3/4-10
- ⊙ - Tapped Hole on Top Retainers 3/8-16, on Pistons - 1/2-13
- ⊗ - Air Fitting - 1/2 NPTF or 3/8 NPTF
- ⊗ - Combination Stud Air Fitting Stud - 3/4-16; Air Fitting - 1/4 NPTF

AIRSPRING ROLLING LOBES

Part No.	Side View With Extended And Compressed Height	Upper Mounting View	Lower Mounting View	Manufacturer Numbers
1R13-174 Flexmember 566-26-3-078 Piston 566-20-7-152		ASA-92-8-401 		DAYNA/ SPICER SR1VA101
1R13-176 Flexmember 566-26-3-078 Piston 566-20-7-154		ASA-92-8-325 		Conti 1010-16S533 FIRESTONE 8713 W013588713 HENDRICKSON C-22948 TRIANGLE 8533
1R13-177 Flexmember 566-26-3-078 Piston 566-20-7-154		ASA-92-8-274 		Conti 1010-16S526 FIRESTONE 8708 HENDRICKSON C-21966 TRIANGLE 8526
1R13-179 Flexmember 566-26-3-078 Piston 566-20-7-152		ASA-92-8-245 		
1R13-181 Flexmember 566-26-3-051 Piston 566-20-7-124		ASA-92-8-245 		

-  - Bolt or Stud 1/2-13 or 1/2-20
-  - Air Fitting - 1/4 NPTF
-  - Stud - 3/4-10
-  - Tapped Hole on Top Retainers 3/8-16, on Pistons - 1/2-13
-  - Air Fitting - 1/2 NPTF or 3/8 NPTF
-  - Combination Stud Air Fitting Stud - 3/4-16; Air Fitting - 1/4 NPTF

Part No.	Side View With Extended And Compressed Height	Upper Mounting View	Lower Mounting View	Manufacturer Numbers
1R13-182 Flexmember 566-26-3-051 Piston 566-20-7-124		ASA-92-8-243 		
1R13-188 Flexmember 566-26-3-078 Piston 566-20-7-314		ASA-92-8-424 		DAYNA/ SPICER SR1VA101-1 SR1VA105
1R13-189 Flexmember 566-26-3-078 Piston 566-20-7-152		ASA-92-8-230 		
1R13-207 Flexmember 566-26-3-081 Piston 566-20-7-106		ASA-92-8-243 		FIRESTONE W013588753 WATSON & CHALIN AS0098
1R13-208 Flexmember 566-26-3-071 Piston 566-20-7-235		ASA-92-8-249 		

- - Bolt or Stud 1/2-13 or 1/2-20
- ⊗ - Air Fitting - 1/4 NPTF
- - Stud - 3/4-10
- ⊗ (with dot) - Tapped Hole on Top Retainers 3/8-16, on Pistons - 1/2-13
- ⊗ (with cross) - Air Fitting - 1/2 NPTF or 3/8 NPTF
- ⊗ (with circle) - Combination Stud Air Fitting Stud - 3/4-16; Air Fitting - 1/4 NPTF

AIRSPRING ROLLING LOBES

Part No.	Side View With Extended And Compressed Height	Upper Mounting View	Lower Mounting View	Manufacturer Numbers
1R13-210 Flexmember 566-26-3-081 Piston 566-20-7-106		ASA-92-8-240 		
1R13-216 Flexmember 566-26-3-072 Piston 566-20-7-097		ASA-92-8-245 		
1R14-018 Flexmember 566-28-3-021 Piston 566-20-7-096		ASA-92-8-028 		Conti 11105-17A365 DAYTON 352-9149 FIRESTONE 9149 GILLIG 53-13188 INT'L/ NAVISTAR 554776C1 LOAD GUARD SC2043 PEERLESS 0550-00010 TAURUS AS621-9149 TRIANGLE 8365
1R14-019 Flexmember 566-28-3-020 Piston 566-20-7-097		ASA-92-8-028 		Conti 11105-21A369 11105-21A370 FIRESTONE 9152 HENDRICKSON B-7128 INT'L/ NAVISTAR 554777C1 LOAD GUARD SC2044 PEERLESS 0550-00080 0550-00081 TAURUS AS622-9156 TRIANGLE 8370
1R14-024 Flexmember 566-28-3-021 Piston Not Included		ASA-92-8-078 	USE EXISTING GOODYEAR ENGINEERED PRODUCT PISTON	INT'L/ NAVISTAR 1681741C1 LOAD GUARD SC2112 PEERLESS 0550-00060 TAURUS AS621-9181

- Bolt or Stud 1/2-13 or 1/2-20
- Air Fitting - 1/4 NPTF
- Stud - 3/4-10
- Tapped Hole on Top Retainers 3/8-16, on Pistons - 1/2-13
- Air Fitting - 1/2 NPTF or 3/8 NPTF
- Combination Stud Air Fitting Stud - 3/4-16; Air Fitting - 1/4 NPTF

Part No.	Side View With Extended And Compressed Height	Upper Mounting View	Lower Mounting View	Manufacturer Numbers
1R14-025 Flexmember 566-28-3-020 Piston <u>Not Included</u>	<p>1R14-025 Service Assembly of 1R14-019</p>	ASA-92-8-078 	USE EXISTING GOODYEAR ENGINEERED PRODUCTS PISTON	<u>INT'L / NAVISTAR</u> 1681742C1 <u>LOAD GUARD</u> SC2111
1R14-026 Flexmember 566-28-3-021 Piston 566-20-7-096	<p>1R14-026</p>	ASA-92-8-028 		<u>Conti</u> 11105-17A364 <u>DAYTON</u> 352-9148 <u>FIRESTONE</u> 9148 <u>INT'L / NAVISTAR</u> 554778C1 <u>LOAD GUARD</u> SC2042 <u>PEERLESS</u> 0550-00070 <u>TAURUS</u> AS621-9148 <u>TRIANGLE</u> 8364
1R14-027 Flexmember 566-28-3-021 Piston <u>Not Included</u>	<p>1R14-027 Service Assembly of 1R14-026</p>	ASA-92-8-028 	USE EXISTING GOODYEAR ENGINEERED PRODUCTS PISTON	<u>INT'L / NAVISTAR</u> 1681743C1 <u>LOAD GUARD</u> SC2113 <u>TAURUS</u> AS621-9198
1R14-028 Flexmember 566-28-3-021 Piston 566-20-7-096	<p>1R14-028</p>	ASA-92-8-031 	USE EXISTING GOODYEAR ENGINEERED PRODUCTS PISTON	<u>Conti</u> 11105-17A316 11105-17A366 <u>DAYTON</u> 352-9177 <u>FIRESTONE</u> 9177 9179 <u>HDA</u> PMABG-9177B <u>HENDRICKSON</u> B-2065 <u>INT'L / NAVISTAR</u> 554779C1 <u>LOAD GUARD</u> SC2046 <u>NEWAY</u> 905-57-003 AR-1115-1-F <u>R & S TRUCK & BODY</u> 1090216 <u>RIDEWELL</u> 1003589177C S-2573-C S-4695-C S-4797-C <u>TAURUS</u> AS621-9177 AS621-9179 <u>TRIANGLE</u> 8316 8366 <u>WATSON & CHALIN</u> AS-0010

- Bolt or Stud 1/2-13 or 1/2-20
- Tapped Hole on Top Retainers 3/8-16, on Pistons - 1/2-13
- Air Fitting - 1/4 NPTF
- Air Fitting - 1/2 NPTF or 3/8 NPTF
- Stud - 3/4-10
- Combination Stud Air Fitting Stud - 3/4-16; Air Fitting - 1/4 NPTF

AIRSPRING ROLLING LOBES

Part No.	Side View With Extended And Compressed Height	Upper Mounting View	Lower Mounting View	Manufacturer Numbers
1R14-029 Flexmember 566-28-3-021 Piston Not Included		ASA-92-8-079 	USE EXISTING GOODYEAR ENGINEERED PRODUCTS PISTON	INT'L/ NAVISTAR 1681744C1 LOAD GUARD SC2114 NEWAY 900-57-001 RIDEWELL 1013589159C TAURUS AS621-9159
1R14-030 Flexmember 566-28-3-020 Piston 566-20-7-097		ASA-92-8-031 		Conti 11105-21A318 DAYTON 352-9158 FIRESTONE 9158 HENDRICKSON 36514-1 36514-4 B-12514-004 B-2063 INT'L/ NAVISTAR 554780C1 LOAD GUARD SC2045 NEWAY 905-57-005 905-57-069 AR-1215-1-F RIDEWELL 1003589158C S-2574-C TAURUS AS622-9158 TRIANGLE 8318
1R14-031 Flexmember 566-28-3-020 Piston Not Included		ASC-92-8-079 	USE EXISTING GOODYEAR ENGINEERED PRODUCTS PISTON	INT'L/ NAVISTAR 1681745C1 LOAD GUARD SC2115 NEWAY 900-44-197 RIDEWELL 1013589154C TAURUS AS622-9154
1R14-037 Flexmember 566-28-3-015 Piston 566-20-7-334		ASA-92-8-028 		Conti 11105-15A414 DAYTON 352-9215 FIRESTONE 9215 HENDRICKSON B-3648 INT'L/ NAVISTAR 554781C1 LOAD GUARD SC2047 TRIANGLE 8414
1R14-038 Flexmember 566-28-3-015 Piston 566-20-7-334		ASA-92-8-031 		Conti 11105-15A415 DAYTON 352-9200 FIRESTONE 9200 HENDRICKSON B-3839 INT'L/ NAVISTAR 1681746C1 LOAD GUARD SC2116 RIDEWELL 1003589200C S-2572-C SUSPENSIONS INC. 200458 TRIANGLE 8415 WATSON & CHALIN AS-0082

- Bolt or Stud 1/2-13 or 1/2-20
- Air Fitting - 1/4 NPTF
- Stud - 3/4-10
- Tapped Hole on Top Retainers 3/8-16, on Pistons - 1/2-13
- Air Fitting - 1/2 NPTF or 3/8 NPTF
- Combination Stud Air Fitting Stud - 3/4-16; Air Fitting - 1/4 NPTF

Part No.	Side View With Extended And Compressed Height	Upper Mounting View	Lower Mounting View	Manufacturer Numbers
1R14-039 Flexmember 566-28-3-015 Piston 566-20-7-334		ASA-92-8-100 		Conti 11105C-16A320 11105C-16A782 DAYTON 352-8050 FIRESTONE 8050 HENDRICKSON 36514-13 B-4771 INT'L/ NAVISTAR 1685174C1 LOAD GUARD SC2052 REYCO 23631-01 TRIANGLE 8320 WATSON & CHALIN AS-0039
1R14-042 Flexmember 566-28-3-015 Piston 566-20-7-334-03		ASA-92-8-049 		Conti 11105C-16A378 FIRESTONE 8052 HENDRICKSON 36514-12 B-12514-012 INT'L/ NAVISTAR 1681747C1 LOAD GUARD SC2121 TRIANGLE 8378 WATSON & CHALIN AS-0078
1R14-045 Flexmember 566-28-3-020 Piston 566-20-7-097		ASA-92-8-049 		Conti 11105-21A313 FIRESTONE 8792 9122 HENDRICKSON 36514-2 36514-8 B-3467 INT'L/ NAVISTAR 1681748C1 LOAD GUARD SC2098 TRIANGLE 8313
1R14-052 Flexmember 566-28-3-015 Piston 566-20-7-334		ASA-92-8-122 		HENDRICKSON B-9001
1R14-060 Flexmember 566-28-3-020 Piston Not Included		ASA-92-8-116 	USE EXISTING GOODYEAR ENGINEERED PRODUCTS PISTON	INT'L/ NAVISTAR 1681749C1 LOAD GUARD SC2099

- - Bolt or Stud 1/2-13 or 1/2-20
- ⊗ - Air Fitting - 1/4 NPTF
- - Stud - 3/4-10
- ◐ - Tapped Hole on Top Retainers 3/8-16, on Pistons - 1/2-13
- ⊗ - Air Fitting - 1/2 NPTF or 3/8 NPTF
- ⊗ - Combination Stud Air Fitting Stud - 3/4-16; Air Fitting - 1/4 NPTF

AIRSPRING ROLLING LOBES

Part No.	Side View With Extended And Compressed Height	Upper Mounting View	Lower Mounting View	Manufacturer Numbers
1R14-094 Flexmember 566-28-3-015 Piston 566-20-7-334-03		ASA-92-8-223 		GILLIG 53-20415-0001
1R14-101 Flexmember 566-28-3-021 Piston 566-20-7-080		ASA-92-8-048 		FLXIBLE 87-0808-00001 97-5382-001 97-6694-1
1R14-106 Flexmember 566-28-3-021 Piston 566-20-7-188		ASA-92-8-279 		MCI 12-03-1029
1R14-108 Flexmember 566-28-3-015 Piston 566-20-7-334		ASA-92-8-031 		
1R14-112 Flexmember 566-28-3-024 Piston 566-20-7-050		ASA-92-8-221 		FLXIBLE 6-336-183 GMC 2052623 2054879 2090412 G1017370 G1050310

- Bolt or Stud 1/2-13 or 1/2-20
- Air Fitting - 1/4 NPTF
- Stud - 3/4-10
- Tapped Hole on Top Retainers 3/8-16, on Pistons - 1/2-13
- Air Fitting - 1/2 NPTF or 3/8 NPTF
- Combination Stud Air Fitting Stud - 3/4-16; Air Fitting - 1/4 NPTF

Part No.	Side View With Extended And Compressed Height	Upper Mounting View	Lower Mounting View	Manufacturer Numbers
1R14-113 Flexmember 566-28-3-030 Piston 566-20-7-181	<p>29.7 9.5</p>	ASC-92-8-049 <p>5.50 11.30</p>	<p>7.87 10.2</p>	<u>Conti</u> 11105-22S750 11105-22S764 <u>FIRESTONE</u> 5505 <u>NEWAY</u> 905-57-103
1R14-115 Flexmember 566-28-3-021 Piston 566-20-7-097	<p>23.7 8.9</p>	ASA-92-8-028 <p>6.25 11.30</p>	<p>7.87 10.20</p>	<u>Conti</u> 11105-17A367 <u>FIRESTONE</u> 9961 <u>RIDEWELL</u> 1003589961C <u>TAURUS</u> AS621-9961 <u>TRIANGLE</u> 8367
1R14-124 Flexmember 566-28-3-021 Piston 566-20-7-217	<p>22.0 8.8</p>	ASA-92-8-048 <p>3.12 6.25 11.30</p>	<p>7.87 10.10</p>	<u>FLXIBLE</u> T14-1035
1R14-127 Flexmember 566-28-3-031 Piston 566-20-7-181	<p>30.8 10.1</p>	ASA-92-8-100 <p>1.38 7.75 11.30</p>	<p>7.87 10.10</p>	<u>Conti</u> 11105-22S712 <u>FIRESTONE</u> 9264 <u>HENDRICKSON</u> C-13122 <u>RIDEWELL</u> 1000002 <u>TRIANGLE</u> 8539
1R14-130 Flexmember 566-28-3-021 Piston 566-20-7-096	<p>22.5 7.2</p>	ASA-92-8-318 <p>5.50 11.30</p>	<p>7.87 10.20</p>	<u>Conti</u> 11105-17A507 <u>FIRESTONE</u> 8778

- - Bolt or Stud 1/2-13 or 1/2-20
- ⊗ - Air Fitting - 1/4 NPTF
- - Stud - 3/4-10
- ⊙ - Tapped Hole on Top Retainers 3/8-16, on Pistons - 1/2-13
- ⊗ - Air Fitting - 1/2 NPTF or 3/8 NPTF
- ⊗ - Combination Stud Air Fitting Stud - 3/4-16; Air Fitting - 1/4 NPTF

AIRSPRING ROLLING LOBES

Part No.	Side View With Extended And Compressed Height	Upper Mounting View	Lower Mounting View	Manufacturer Numbers
1R14-137 Flexmember 566-28-3-021 Piston 566-20-7-096	<p>22.5 7.2</p>	ASA-92-8-049 <p>5.50 11.30</p>	<p>7.87 10.20</p>	Conti 11105-19A431 FIRESTONE 9134 NEWAY 905-57-125 TRIANGLE 8431
1R14-141 Flexmember 566-28-3-021 Piston 566-20-7-189	<p>19.5 9.7</p>	ASA-92-8-272 <p>6.25 3.12 .500-14 NPTF 11.30</p>	<p>7.87 9.50</p>	MCI 12-01-1002 12-01-1048
1R14-147 Flexmember 566-28-3-015 Piston 566-20-7-334-03	<p>18.0 5.6</p>	ASA-92-8-223 <p>2.75 3.75 6.50 11.30</p>	<p>7.87 11.70</p>	Conti 11105C-16A380 FIRESTONE 8053 NEWAY 905-57-098 TRIANGLE 8380
1R14-154 Flexmember 566-28-3-020 Piston 566-20-7-097	<p>25.8 8.9</p>	ASA-92-8-361 <p>6.20 11.30</p>	<p>7.87 10.20</p>	WATSON & CHALIN AS-0023-1G
1R14-159 Flexmember 566-28-3-021 Piston 566-20-7-096	<p>22.5 7.7</p>	ASA-92-8-049 <p>5.50 11.30</p>	<p>7.87 10.20</p>	Conti 11105-17A405 FIRESTONE 9164 NEWAY 905-57-111 R & S TRUCK & BODY 1090326 TRIANGLE 8405

- - Bolt or Stud 1/2-13 or 1/2-20
- ⊗ - Air Fitting - 1/4 NPTF
- ⊙ - Stud - 3/4-10
- ⊕ - Tapped Hole on Top Retainers 3/8-16, on Pistons - 1/2-13
- ⊗ - Air Fitting - 1/2 NPTF or 3/8 NPTF
- ⊗ - Combination Stud Air Fitting Stud - 3/4-16; Air Fitting - 1/4 NPTF

Part No.	Side View With Extended And Compressed Height	Upper Mounting View	Lower Mounting View	Manufacturer Numbers
1R14-160 Flexmember 566-28-3-021 Piston 566-20-7-097		ASA-92-8-049 		<u>Conti</u> 11105-17A377 <u>FIRESTONE</u> 9144 <u>NEWAY</u> 905-57-155 <u>TRIANGLE</u> 8523
1R14-167 Flexmember 566-28-3-015 Piston 566-20-7-223		ASA-92-8-393 		
1R14-170 Flexmember 566-28-3-020 Piston 566-20-7-097		ASA-92-8-174 		<u>Conti</u> 11105-22A752 <u>NEWAY</u> 905-57-102 <u>WATSON & CHALIN</u> AS-0047G
1R14-171 Flexmember 566-28-3-015 Piston 566-20-7-152		ASA-92-8-237 		<u>Conti</u> 11105A-16P523 <u>FIRESTONE</u> 8091 <u>HENDRICKSON</u> C-20901
1R14-172 Flexmember 566-28-3-042 Piston 566-20-7-152		ASA-92-8-237 		<u>Conti</u> 11105F-17P745 <u>HENDRICKSON</u> C-25873

- - Bolt or Stud 1/2-13 or 1/2-20
- ⊗ - Air Fitting - 1/4 NPTF
- - Stud - 3/4-10
- ⊗ (with dot) - Tapped Hole on Top Retainers 3/8-16, on Pistons - 1/2-13
- ⊗ (with cross) - Air Fitting - 1/2 NPTF or 3/8 NPTF
- ⊗ (with circle) - Combination Stud Air Fitting Stud - 3/4-16; Air Fitting - 1/4 NPTF

AIRSPRING ROLLING LOBES

Part No.	Side View With Extended And Compressed Height	Upper Mounting View	Lower Mounting View	Manufacturer Numbers
1R14-174 Flexmember 566-28-3-020 Piston 566-20-7-097	<p>25.8 8.9</p>	ASA-92-8-049 <p>5.50 11.30</p>	<p>7.87 10.20</p>	Conti 11105-22A530 FIRESTONE 5503 NEWAY 905-57-200 TRIANGLE 8530 WATSON & CHALIN AS-0047
1R14-175 Flexmember 566-28-3-042 Piston 566-20-7-334	<p>20.3 5.1</p>	ASA-92-8-174 <p>6.20 11.30</p>	<p>7.87 11.70</p>	RIDEWELL 1000008
1R14-177 Flexmember 566-28-3-021 Piston 566-20-7-276	<p>22.5 7.5</p>	ASA-92-8-049 <p>5.50 11.30</p>	<p>7.87 11.10</p>	
1R14-182 Flexmember 566-28-3-043 Piston 566-20-7-304	<p>17.0 8.5</p>	ASA-92-8-272 <p>6.25 3.12 .500-14 NPTF 11.30</p>	<p>7.87 9.50</p>	
1R14-183 Flexmember 566-28-3-044 Piston 566-20-7-152	<p>18.0 5.9</p>	ASA-92-8-100 <p>7.75 1.38 11.30</p>	<p>5.9 9.9</p>	

- - Bolt or Stud 1/2-13 or 1/2-20
- ⊗ - Air Fitting - 1/4 NPTF
- - Stud - 3/4-10
- ⊗ - Tapped Hole on Top Retainers 3/8-16, on Pistons - 1/2-13
- ⊗ - Air Fitting - 1/2 NPTF or 3/8 NPTF
- ⊗ - Combination Stud Air Fitting Stud - 3/4-16; Air Fitting - 1/4 NPTF

Part No.	Side View With Extended And Compressed Height	Upper Mounting View	Lower Mounting View	Manufacturer Numbers
1R14-190 Flexmember 566-28-3-044 Piston 566-20-7-152	<p>18.0 5.9</p>	ASA-92-8-237 <p>5.50 1.38 11.40</p>	<p>5.9 9.9</p>	Conti 11105F-17P745 WATSON & CHALIN AS-0144
1R14-205 Flexmember 566-28-3-015 Piston 566-20-7-230	<p>14.6 4.6</p>	ASA-92-8-434 <p>.750-14 NPTF M12x1.75 6.75 11.30</p>	<p>10.00</p>	
1R14-209 Flexmember 566-28-3-020 Piston 566-20-7-096	<p>24.2 7.2</p>	ASA-92-8-237 <p>5.50 1.38 11.30</p>	<p>7.87 10.20</p>	
1R14-215 Flexmember 566-28-3-021 Piston 566-20-7-327	<p>22.5 7.3</p>	ASA-92-8-049 <p>5.50 11.30</p>	<p>7.87 10.20</p>	
1R14-216 Flexmember 566-28-3-015 Piston 566-20-7-334	<p>18.0 4.7</p>	ASA-92-8-434 <p>.750-14 NPTF M12x1.75 6.75 11.30</p>	<p>7.87 11.70</p>	

- - Bolt or Stud 1/2-13 or 1/2-20
- ⊗ - Air Fitting - 1/4 NPTF
- ⊗ - Stud - 3/4-10
- ⊗ - Tapped Hole on Top Retainers 3/8-16, on Pistons - 1/2-13
- ⊗ - Air Fitting - 1/2 NPTF or 3/8 NPTF
- ⊗ - Combination Stud Air Fitting Stud - 3/4-16; Air Fitting - 1/4 NPTF

AIRSPRING ROLLING LOBES

Part No.	Side View With Extended And Compressed Height	Upper Mounting View	Lower Mounting View	Manufacturer Numbers
<p>1R14-218</p> <p>Flexmember 566-28-3-021</p> <p>Piston 566-20-7-276</p>	<p>1R14-218</p>	<p>ASA-92-8-049</p>		
<p>1R15-001</p> <p>Flexmember 566-30-3-001</p> <p>Piston 566-20-7-152</p>	<p>1R15-001</p>	<p>ASA-92-8-237</p>		

- Bolt or Stud 1/2-13 or 1/2-20
- Tapped Hole on Top Retainers 3/8-16, on Pistons - 1/2-13
- Air Fitting - 1/4 NPTF
- Air Fitting - 1/2 NPTF or 3/8 NPTF
- Stud - 3/4-10
- Combination Stud Air Fitting Stud - 3/4-16; Air Fitting - 1/4 NPTF

Part No.	Side View With Extended And Compressed Height	Upper Mounting View	Lower Mounting View	Manufacturer Numbers
1S3-011 Piston ASB-06-7-014		ASB-06-5-012 .750-16 UNF-2A outside .125-27 NPTF inside 	.500-13 UNC 	FIRESTONE 4001 LES AUTOBUS G5006637 LINK CAB & SEAT SPRINGS 1101-0001 NOVABUS N12687 PREVOST 95-0208
1S3-013 Piston ASC-06-7-017		ASC-06-5-014 5/16-18 UNC 	.625-11 UNC outside .125 NPTF inside 	FIRESTONE 3000 3001
1S4.5-073 Piston ASC-08-7-194		ASB-08-5-076 .750 smooth outside .125-27 NPTF inside 	.500-13 UNC 	LINK CAB & SEAT SPRINGS 1101-0030
1S4.5-107 Piston ASC-08-7-194		ASB-08-5-129 .750-16 UNC outside .125-27 NPTF inside 	.500-13 UNC 	FIRESTONE 7080
1S4.5-113 Piston 579-08-7-219		ASB-08-5-132 .750 smooth outside .500 O.D. smooth 	.750 smooth outside .125-27 UNC inside 	FIRESTONE 7056 LINK CAB & SEAT SPRINGS 1102-0043

- Bolt or Stud 1/2-13 or 1/2-20
- Air Fitting - 1/4 NPTF
- Stud - 3/4-10
- Tapped Hole on Top Retainers 3/8-16, on Pistons - 1/2-13
- Air Fitting - 1/2 NPTF or 3/8 NPTF
- Combination Stud Air Fitting Stud - 3/4-16; Air Fitting - 1/4 NPTF

Airspring Sleeves

Part No.	Side View With Extended And Compressed Height	Upper Mounting View	Lower Mounting View	Manufacturer Numbers
1S4.5-121 Piston ASC-08-7-157	<p>6.6 2.2</p>	ASB-08-5-201 <p>.375-16 UNC .125-27 NPTF .75 2.65</p>	<p>.375-16 UNC 3.25</p>	Conti SZ70-7065P02 FIRESTONE 7035 SEARS SEAT S-20235 S-9383
1S4.5-179 Piston ASC-08-7-157	<p>6.2 2.2</p>	ASB-08-5-076 <p>.750 smooth outside .125-27 NPTF inside 2.65</p>	<p>.375-16 UNC 3.25</p>	LINK CAB & SEAT SPRINGS 1101-0031
1S4-007 Piston ASC-08-7-139	<p>7.1 2.2</p>	ASB-08-5-007 <p>.375-16 UNC 2.65</p>	<p>.750-16 UNF-2A outside .125-27 NPTF inside 2.87</p>	FIRESTONE 7001 7002 7031 FLXIBLE 97-9999-01867 LINK CAB & SEAT SPRINGS 1101-0020 MACK TRUCK 227QS33
1S4-008 Piston ASC-08-7-005	<p>10.5 4.0</p>	ASB-08-5-006 <p>.750-16 UNF outside .125-27 NPTF inside 2.65</p>	<p>.500-13 UNC 2.12</p>	FIRESTONE 7010 LINK CAB & SEAT SPRINGS 1101-0021 MACK TRUCK 227QS39301
1S4-016 Piston ASC-08-7-137	<p>7.1 2.2</p>	ASB-08-5-132 <p>.500 O.D. Smooth 2.65</p>	<p>.750 smooth outside .125-27 NPTF inside 3.25</p>	INT'L / NAVISTAR 1680378C1

- Bolt or Stud 1/2-13 or 1/2-20
- Air Fitting - 1/4 NPTF
- Stud - 3/4-10
- Tapped Hole on Top Retainers 3/8-16, on Pistons - 1/2-13
- Air Fitting - 1/2 NPTF or 3/8 NPTF
- Combination Stud Air Fitting Stud - 3/4-16; Air Fitting - 1/4 NPTF

Part No.	Side View With Extended And Compressed Height	Upper Mounting View	Lower Mounting View	Manufacturer Numbers
1S4-030 Piston ASC-08-7-093		ASB-08-5-006 .750-16 UNF outside .125-27 NPTF inside 	.500-13 UNC 	<u>FREIGHTLINER</u> 20-12461
1S4-035 Piston ASC-08-7-163		ASB-08-5-132 .500 O.D. smooth 	.750 smooth outside .125-27 UNC inside 	<u>FIRESTONE</u> 7003 7050 7055
1S4-042 Piston ASC-08-7-219		AS2-08-5-007 .375-16 UNC 	.750 smooth 	<u>VOLVO</u> 66003-0007
1S4-044 Piston ASC-08-7-194		ASB-08-5-076 .750 smooth outside .125-27 NPTF inside 	.500-13 UNC 	<u>Conti</u> SZ70-5067 <u>LINK CAB & SEAT SPRINGS</u> 1101-0023
1S4-056 Piston ASC-08-7-194		ASB-08-5-129 .750-16 UNC outside .125-27 NPTF inside 	.500-13 UNC 	<u>FIRESTONE</u> 7040 <u>LINK CAB & SEAT SPRINGS</u> 1101-0024

- Bolt or Stud - 1/2-13 or 1/2-20
- Air Fitting - 1/4 NPTF
- Stud - 3/4-10
- Tapped Hole on Top Retainers 3/8-16, on Pistons - 1/2-13
- Air Fitting - 1/2 NPTF or 3/8 NPTF
- Combination Stud Air Fitting Stud - 3/4-16; Air Fitting - 1/4 NPTF

Airspring Sleeves

Part No.	Side View With Extended And Compressed Height	Upper Mounting View	Lower Mounting View	Manufacturer Numbers
1S4-058 Piston ASC-08-7-139		AS2-08-5-007 .375-16 UNC 	.750 smooth outside .125-27 UNC inside 	FIRESTONE 7086
1S4-067 Piston ASC-08-7-137		ASB-08-5-024 .750-16 UNF outside .125-27 NPTF inside 	.750 smooth outside .125-27 NPTF inside 	FIRESTONE 7007 MACK TRUCK 227QS34B
1S4-074 Piston ASC-08-7-134		AS2-08-5-007 .375-16 UNC 	.750 smooth outside .125-27 NPTF inside 	VOLVO 66003-3201
1S4-123 Piston ASC-08-7-157		ASB-08-5-170 	.375-16 UNC 	Conti SZ70-5060P02 LINK CAB & SEAT SPRINGS 1102-0022
1S4-173 Piston ASC-08-7-137		ASB-08-5-172 3/4 - 16 UNF 2A 	.750 smooth outside .125-27 NPTF inside 	

- Bolt or Stud 1/2-13 or 1/2-20
- Air Fitting - 1/4 NPTF
- Stud - 3/4-10
- Tapped Hole on Top Retainers 3/8-16, on Pistons - 1/2-13
- Air Fitting - 1/2 NPTF or 3/8 NPTF
- Combination Stud Air Fitting Stud - 3/4-16; Air Fitting - 1/4 NPTF

Part No.	Side View With Extended And Compressed Height	Upper Mounting View	Lower Mounting View	Manufacturer Numbers
1S4-175 Piston ASC-08-7-157		ASB-08-5-076 .750 smooth outside .125-27 NPTF inside 	.375-16 UNC 	<u>LINK CAB & SEAT SPRINGS</u> 1101-0025
1S5-005 Piston ASC-08-7-005		ASB-08-5-006 .750-16 UNF outside .125-27 NPTF inside 	.500-13 UNC 	<u>LINK CAB & SEAT SPRINGS</u> 1101-0040
1S5-006 Piston ASC-08-7-005		ASB-08-5-006 .750-16 UNF outside .125-27 NPTF inside 	.500-13 UNC 	<u>FIRESTONE</u> 7017 <u>LINK CAB & SEAT SPRINGS</u> 1101-0041
1S5-010 Piston ASC-08-7-139		AS2-08-5-007 .375-16 UNC 	.750-16 UNF outside .125 NPTF inside 	
1S5-032 Piston ASC-08-7-163		ASB-08-5-132 .500 O.D. smooth 	.750 smooth outside .125-27 UNC inside 	<u>LINK CAB & SEAT SPRINGS</u> 1101-0042 1101-A042





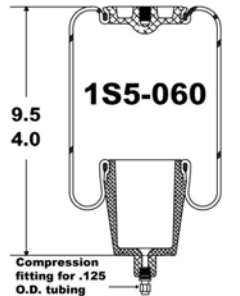
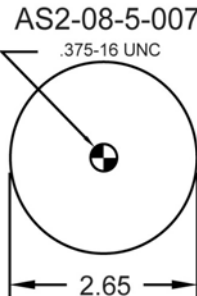
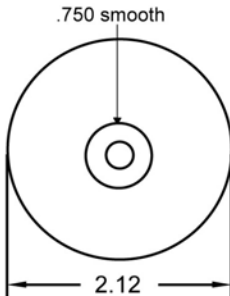
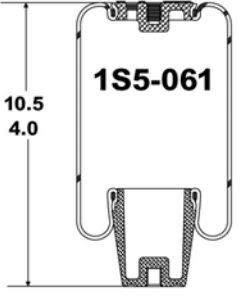
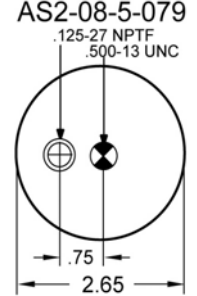
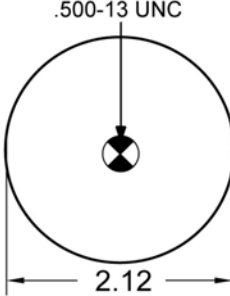
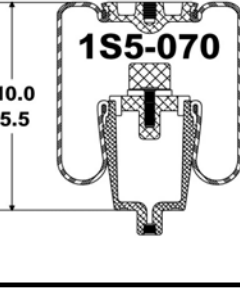
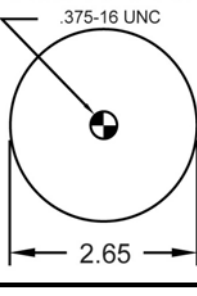
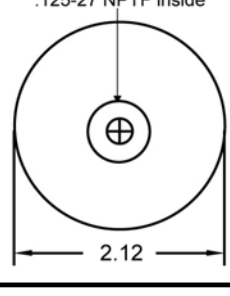
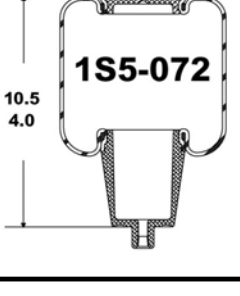
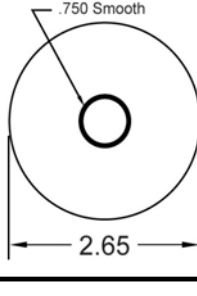
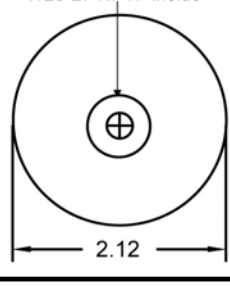
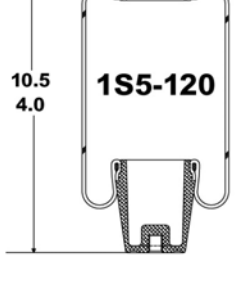
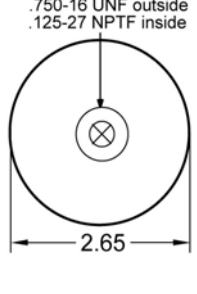
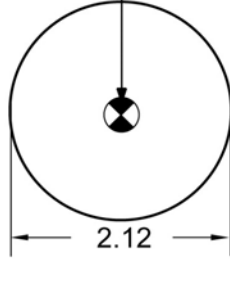

- Bolt or Stud 1/2-13 or 1/2-20
- Tapped Hole on Top Retainers 3/8-16, on Pistons - 1/2-13
- Air Fitting - 1/4 NPTF
- Air Fitting - 1/2 NPTF or 3/8 NPTF
- Stud - 3/4-10
- Combination Stud Air Fitting Stud - 3/4-16; Air Fitting - 1/4 NPTF

Airspring Sleeves

Part No.	Side View With Extended And Compressed Height	Upper Mounting View	Lower Mounting View	Manufacturer Numbers
1S5-038 Piston ASC-08-7-194		ASB-08-5-076 .750 smooth outside .125-27 NPTF inside 	.500-13 UNC 	FIRESTONE 7081 LINK CAB & SEAT SPRINGS 1101-0043
1S5-040 Piston ASC-08-7-137		ASB-08-5-132 .500 O.D. Smooth 	.750 smooth outside .125-27 NPTF inside 	FIRESTONE 7087 FREIGHTLINER GYR1S5040
1S5-045 Piston ASC-08-7-139		ASB-08-5-132 .500 O.D. smooth 	.750-16 UNF-2A outside .125-27 NPTF inside 	FREIGHTLINER GYR1S5045
1S5-055 Piston ASC-08-7-194		AS2-08-5-063 .750 smooth outside .125-27 NPTF inside 	.500-13 UNC 	MACK TRUCK 227QS38B
1S5-057 Piston 579-08-7-157		ASB-08-5-170 .125-27 NPTF .375-16 UNC 	.375-16 UNC 	Conti SZ70-8077P02 FIRESTONE 7108 MILSCO 07067A

- Bolt or Stud 1/2-13 or 1/2-20
- Air Fitting - 1/4 NPTF
- Stud - 3/4-10
- Tapped Hole on Top Retainers 3/8-16, on Pistons - 1/2-13
- Air Fitting - 1/2 NPTF or 3/8 NPTF
- Combination Stud Air Fitting Stud - 3/4-16; Air Fitting - 1/4 NPTF

Part No.	Side View With Extended And Compressed Height	Upper Mounting View	Lower Mounting View	Manufacturer Numbers
1S5-060 Piston ASC-08-7-219		AS2-08-5-007 .375-16 UNC 	.750 smooth 	<u>VOLVO</u> 66003-0004
1S5-061 Piston ASC-08-7-194		AS2-08-5-079 .125-27 NPTF .500-13 UNC 	.500-13 UNC 	
1S5-070 Piston ASB-08-7-134		AS2-08-5-007 .375-16 UNC 	.750 smooth outside .125-27 NPTF inside 	<u>VOLVO</u> 8169029
1S5-072 Piston ASC-08-7-219		AS2-08-5-066 .750 Smooth 	.750 smooth outside .125-27 NPTF inside 	<u>INT'L / NAVISTAR</u> 2012771C1
1S5-120 Piston ASC-08-7-194		ASB-08-5-129 .750-16 UNF outside .125-27 NPTF inside 	.500-13 UNC 	<u>FIRESTONE</u> 7014 7017 7042 7044





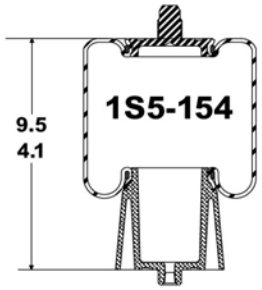
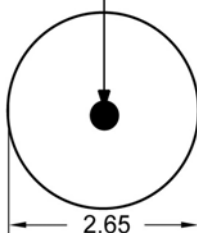
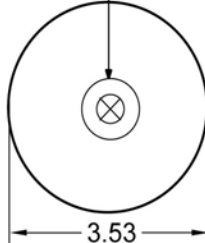
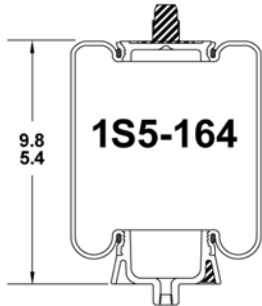
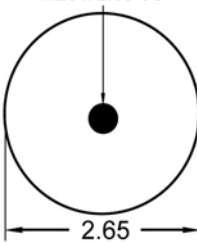
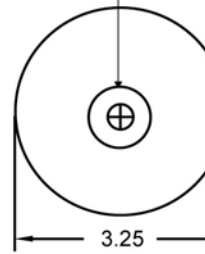
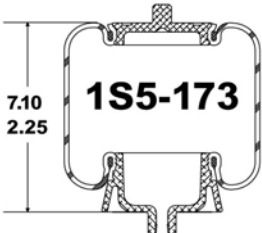
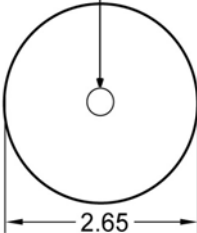
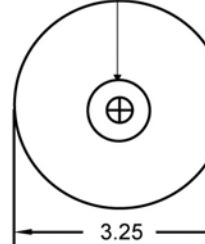
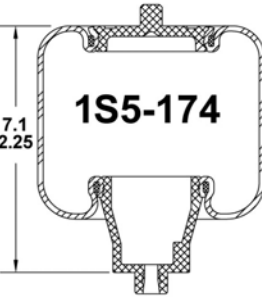
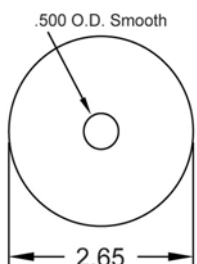
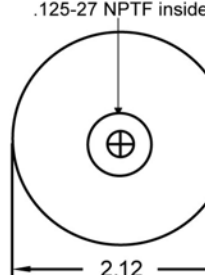
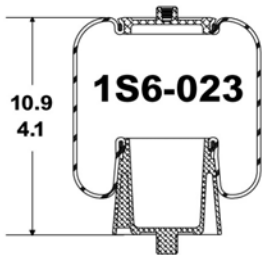
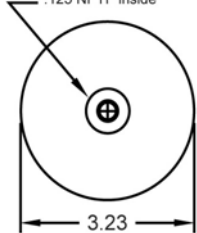
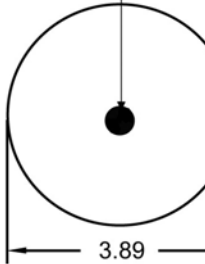

-  - Bolt or Stud 1/2-13 or 1/2-20
-  - Air Fitting - 1/4 NPTF
-  - Stud - 3/4-10
-  - Tapped Hole on Top Retainers 3/8-16, on Pistons - 1/2-13
-  - Air Fitting - 1/2 NPTF or 3/8 NPTF
-  - Combination Stud Air Fitting Stud - 3/4-16; Air Fitting - 1/4 NPTF

Airspring Sleeves

Part No.	Side View With Extended And Compressed Height	Upper Mounting View	Lower Mounting View	Manufacturer Numbers
1S5-122 Piston ASC-08-7-213		ASB-08-5-145 .75 - 16 UNF 	.750 smooth outside .125 NPTF inside 	
1S5-133 Piston ASC-08-7-157		ASB-08-5-076 .750 smooth outside .125-27 NPTF inside 	.375-16 UNC 	LINK CAB & SEAT SPRINGS 1101-0045
1S5-135 Piston ASC-08-7-157		ASB-08-5-170 .375-16 UNC .125-27 NPTF 	.375-16 UNC 	LINK CAB & SEAT SPRINGS 1101-0044
1S5-146 Piston 579-08-7-137		ASB-08-5-190 M20 x 2.50-6G 	.750 smooth outside .125-27 NPTF inside 	MACK TRUCK 227QS45M
1S5-152 Piston ASC-08-7-219		AS2-08-5-112 .375-16 UNC 	.750 smooth outside .125-27 UNC inside 	FIRESTONE 7110

- Bolt or Stud 1/2-13 or 1/2-20
- Air Fitting - 1/4 NPTF
- Stud - 3/4-10
- Tapped Hole on Top Retainers 3/8-16, on Pistons - 1/2-13
- Air Fitting - 1/2 NPTF or 3/8 NPTF
- Combination Stud Air Fitting Stud - 3/4-16; Air Fitting - 1/4 NPTF

Part No.	Side View With Extended And Compressed Height	Upper Mounting View	Lower Mounting View	Manufacturer Numbers
1S5-154 Piston ASC-08-7-213	 9.5 4.1	ASB-08-5-190 M20 x 2.50-6G  2.65	.750-16 smooth outside .125-27 NPTF inside  3.53	<u>MACK TRUCK</u> 227QS312BM
1S5-164 Piston ASC-08-7-137	 9.8 5.4	ASB-08-5-190 M20 x 2.50-6G  2.65	.750 smooth outside .125-27 NPTF inside  3.25	
1S5-173 Piston ASC-08-7-137	 7.10 2.25	ASB-08-5-132 .500 O.D. smooth  2.65	.750 smooth outside .125-27 NPTF inside  3.25	<u>FREIGHTLINER</u> 18-41909-0
1S5-174 Piston ASC-08-7-232	 7.1 2.25	ASB-08-5-132 .500 O.D. Smooth  2.65	.750 smooth outside .125-27 NPTF inside  2.12	
1S6-023 Piston ASB-08-7-079	 10.9 4.1	ASB-08-5-048 M20 x 2.50-6G outside .125 NPTF inside  3.23	M20 x 2.50-6G  3.89	





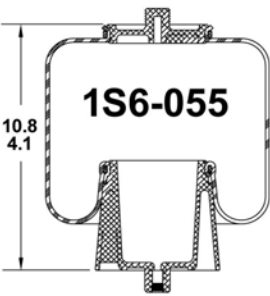
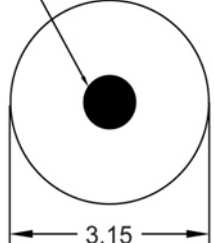
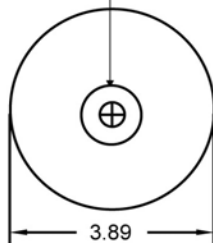

-  - Bolt or Stud 1/2-13 or 1/2-20
-  - Tapped Hole on Top Retainers 3/8-16, on Pistons - 1/2-13
-  - Air Fitting - 1/4 NPTF
-  - Air Fitting - 1/2 NPTF or 3/8 NPTF
-  - Stud - 3/4-10
-  - Combination Stud Air Fitting Stud - 3/4-16; Air Fitting - 1/4 NPTF

Airspring Sleeves

Part No.	Side View With Extended And Compressed Height	Upper Mounting View	Lower Mounting View	Manufacturer Numbers
1S6-025 Piston ASC-08-7-215		ASB-08-5-146 	.750 smooth outside .125-27 NPTF inside 	MACK TRUCK 227QS312AM 227QS46M
1S6-026 Piston ASC-08-7-223		AS2-08-5-048 M20 x 2.50-6G outside .125-27 NPTF inside 	.750 smooth 	MACK TRUCK 227QS310BM
1S6-031 Piston ASC-08-7-215 Quick connect fitting for .250" tubing		ASB-08-5-146 M20 x 2.50-6G 	.750 smooth outside .125-27 NPTF inside 	FREIGHTLINER GYR1S6031
1S6-033 Piston ASC-08-7-215		ASB-08-5-146 M20 x 2.50-6g 	.750 smooth outside .125-27 NPTF inside 	
1S6-046 Piston ASC-08-7-215		ASB-08-5-145 .750-16 UNF 	.750 smooth outside .125-27 NPTF inside 	LINK CAB & SEAT SPRINGS 1101-0060

- Bolt or Stud 1/2-13 or 1/2-20
- Air Fitting - 1/4 NPTF
- Stud - 3/4-10
- Tapped Hole on Top Retainers 3/8-16, on Pistons - 1/2-13
- Air Fitting - 1/2 NPTF or 3/8 NPTF
- Combination Stud Air Fitting Stud - 3/4-16; Air Fitting - 1/4 NPTF

Part No.	Side View With Extended And Compressed Height	Upper Mounting View	Lower Mounting View	Manufacturer Numbers
<p>1S6-055 Piston ASC-08-7-215</p>	 <p>10.8 4.1</p> <p>1S6-055</p>	<p>ASB-08-5-146 M20 x 2.50-6G</p>  <p>3.15</p>	<p>.750 smooth outside .125-27 NPTF inside</p>  <p>3.89</p>	

-  - Bolt or Stud 1/2-13 or 1/2-20
-  - Air Fitting - 1/4 NPTF
-  - Stud - 3/4-10
-  - Tapped Hole on Top Retainers 3/8-16, on Pistons - 1/2-13
-  - Air Fitting - 1/2 NPTF or 3/8 NPTF
-  - Combination Stud Air Fitting Stud - 3/4-16; Air Fitting - 1/4 NPTF

FLEX MEMBER INDEX

Flexible Member No.	Piston Number	Air Spring Number	Flexible Member No.	Piston Number	Air Spring Number
556-33-8-335		3B14-464	566-22-3-049	566-20-7-124	1R11-130
556-33-8-335		3B14-459	566-22-3-051	566-20-7-183	1R11-115
556-33-8-335		3B14-457	566-22-3-057	566-20-7-253	1R11-225
556-33-8-335		3B14-455	566-22-3-057	566-20-7-150	1R11-171
556-33-8-335		3B14-450	566-22-3-057	566-20-7-150	1R11-161
566-16-3-007	566-16-7-000-03	1R8-036	566-22-3-060	566-20-7-257	1R11-175
566-16-3-007	566-16-7-021	1R8-034	566-22-3-068	566-20-7-257	1R11-216
566-18-3-003	566-16-7-009	1R9-065	566-22-3-073	566-20-7-308	1R11-224
566-18-3-004	566-16-7-021	1R9-070	566-22-3-079	566-20-7-079	1R11-244
566-18-3-004	566-16-7-000	1R9-056	566-22-3-084	566-20-7-156	1R11-249
566-18-3-004	566-16-7-000	1R9-054	566-22-3-143	566-20-7-120	1R11-243
566-18-3-004	566-16-7-021	1R9-053	566-22-3-143	566-20-7-253	1R11-241
566-18-3-004	Not Included	1R9-047	566-22-3-143	566-20-7-156	1R11-223
566-18-3-004	566-16-7-021	1R9-003	566-22-3-143	566-20-7-239	1R11-191
566-18-3-010	566-16-7-017	1R9-038	566-22-3-143	566-20-7-209	1R11-179
566-18-3-010	566-16-7-017	1R9-025	566-22-3-143	566-20-7-209	1R11-178
566-20-3-021	566-20-7-240	1R10-133	566-22-3-143	566-20-7-240	1R11-170
566-20-3-021	566-20-7-240	1R10-127	566-22-3-143	566-20-7-250	1R11-169
566-20-3-021	566-20-7-237	1R10-122	566-22-3-143	566-20-7-235	1R11-166
566-20-3-021	566-20-7-240	1R10-120	566-22-3-143	566-20-7-239	1R11-149
566-20-3-021	566-20-7-240	1R10-118	566-22-3-143	566-20-7-240	1R11-147
566-20-3-021	566-20-7-077-03	1R10-109	566-22-3-143	566-20-7-240	1R11-143
566-20-3-021	566-20-7-120	1R10-108	566-22-3-143	566-20-7-156	1R11-121
566-20-3-021	566-20-7-240	1R10-105	566-22-3-143	566-20-7-079	1R11-090
566-20-3-021	566-20-7-240	1R10-099	566-22-3-143	566-20-7-120	1R11-088
566-20-3-021	566-20-7-240	1R10-091	566-22-3-143	566-20-7-077-03	1R11-045
566-20-3-021	566-20-7-120	1R10-090	566-22-3-143	566-20-7-036	1R11-039
566-20-3-021	566-20-7-240	1R10-089	566-22-3-143	566-20-7-240	1R11-094
566-20-3-021	566-20-7-240	1R10-087	566-23-8-329		2B14-469
566-20-3-021	Not Included	1R10-085	566-24-3-019	566-20-7-011	1R12-047
566-20-3-022	Not Included	1R10-030	566-24-3-019	566-20-7-011	1R12-014
566-20-3-022	566-20-7-240	1R10-019	566-24-3-024	566-20-7-240	1R12-127
566-20-3-023	566-20-7-240	1R10-137	566-24-3-024	566-20-7-079	1R12-028
566-20-3-027	566-20-7-150	1R10-101	566-24-3-038	566-20-7-053	1R12-669
566-20-3-029	566-20-7-055	1R10-072	566-24-3-038	566-20-7-238	1R12-640
566-22-3-006	566-20-7-079	1R11-018	566-24-3-038	566-20-7-036	1R12-617
566-22-3-021	566-20-7-252	1R11-242	566-24-3-038	566-20-7-237	1R12-586
566-22-3-021	566-20-7-286	1R11-222	566-24-3-038	566-20-7-158	1R12-584
566-22-3-021	566-20-7-287	1R11-221	566-24-3-038	566-20-7-159	1R12-576
566-22-3-021	566-20-7-286	1R11-220	566-24-3-038	566-20-7-235	1R12-567
566-22-3-021	566-20-7-287	1R11-219	566-24-3-038	566-20-7-214	1R12-554
566-22-3-021	566-20-7-253	1R11-205	566-24-3-038	566-20-7-213	1R12-553
566-22-3-021	566-20-7-253	1R11-204	566-24-3-038	566-20-7-215	1R12-552
566-22-3-021	566-20-7-251	1R11-203	566-24-3-038	566-20-7-209	1R12-541
566-22-3-021	566-20-7-252	1R11-202	566-24-3-038	566-20-7-236	1R12-538
566-22-3-021	566-20-7-252	1R11-201	566-24-3-038	566-20-7-005	1R12-509
566-22-3-021	566-20-7-252	1R11-200	566-24-3-038	566-20-7-235	1R12-502
566-22-3-021	566-20-7-014	1R11-162	566-24-3-038	566-20-7-238	1R12-499
566-22-3-021	566-20-7-014	1R11-159	566-24-3-038	566-20-7-036	1R12-494
566-22-3-021	566-20-7-055	1R11-152	566-24-3-038	566-20-7-215	1R12-486
566-22-3-021	566-20-7-055	1R11-151	566-24-3-038	566-20-7-215	1R12-485
566-22-3-021	566-20-7-055	1R11-150	566-24-3-038	566-20-7-215	1R12-484
566-22-3-021	566-20-7-055	1R11-066	566-24-3-038	566-20-7-246	1R12-462
566-22-3-021	566-20-7-014	1R11-047	566-24-3-038	566-20-7-079	1R12-454
566-22-3-021	566-20-7-014	1R11-028	566-24-3-038	566-20-7-235	1R12-441
566-22-3-021	566-20-7-287	1R11-268	566-24-3-038	566-20-7-158	1R12-438
566-22-3-028	566-20-7-055	1R11-075	566-24-3-038	566-20-7-158	1R12-436
566-22-3-042	566-20-7-235	1R11-252	566-24-3-038	566-20-7-246	1R12-423
566-22-3-044	566-20-7-079	1R11-097	566-24-3-038	566-20-7-221	1R12-401
566-22-3-049	566-20-7-124	1R11-232	566-24-3-038	566-20-7-246	1R12-400
566-22-3-049	566-20-7-240	1R11-189	566-24-3-038	566-20-7-240	1R12-396

*The prefixes ASC, ASD, AS3 OR AS4 may be used interchangeably with 566 and may appear on some flex members or pistons.

FLEX MEMBER INDEX (Cont.)

Flexible Member No.	Piston Number	Air Spring Number	Flexible Member No.	Piston Number	Air Spring Number
566-24-3-038	Not Included	1R12-394	566-24-3-067	566-20-7-252	1R12-563
566-24-3-038	566-20-7-079	1R12-369	566-24-3-067	566-20-7-251	1R12-562
566-24-3-038	566-20-7-163	1R12-366	566-24-3-067	566-20-7-253	1R12-561
566-24-3-038	566-20-7-079	1R12-365	566-24-3-067	566-20-7-253	1R12-560
566-24-3-038	566-20-7-080	1R12-358	566-24-3-067	566-20-7-252	1R12-559
566-24-3-038	566-20-7-080	1R12-356	566-24-3-067	566-20-7-252	1R12-558
566-24-3-038	566-20-7-080	1R12-285	566-24-3-067	566-20-7-252	1R12-557
566-24-3-038	566-20-7-080	1R12-220	566-24-3-067	566-20-7-252	1R12-556
566-24-3-038	566-20-7-079	1R12-188	566-24-3-067	566-20-7-253	1R12-555
566-24-3-038	566-20-7-079	1R12-182	566-24-3-067	566-20-7-251	1R12-508
566-24-3-038	566-20-7-080	1R12-155	566-24-3-067	566-20-7-239	1R12-487
566-24-3-038	566-20-7-080	1R12-130	566-24-3-067	566-20-7-014	1R12-465
566-24-3-038	Not Included	1R12-093	566-24-3-067	566-20-7-014	1R12-435
566-24-3-038	566-20-7-080	1R12-092	566-24-3-067	566-20-7-055	1R12-324
566-24-3-038	566-20-7-079	1R12-090	566-24-3-067	566-20-7-164	1R12-309
566-24-3-038	566-20-7-235	1R12-069	566-24-3-067	566-20-7-055	1R12-204
566-24-3-038	566-20-7-080	1R12-066	566-24-3-067	566-20-7-055	1R12-178
566-24-3-038	566-20-7-233	1R12-419	566-24-3-067	566-20-7-055	1R12-156
566-24-3-048	566-20-7-240	1R12-511	566-24-3-067	Not Included	1R12-097
566-24-3-048	566-20-7-240	1R12-304	566-24-3-067	566-20-7-014	1R12-095
566-24-3-048	566-20-7-120	1R12-288	566-24-3-076	566-20-7-158	1R12-655
566-24-3-048	566-20-7-240	1R12-284	566-24-3-076	566-20-7-239	1R12-648
566-24-3-048	566-20-7-120	1R12-217	566-24-3-076	566-20-7-156	1R12-636
566-24-3-048	566-20-7-120	1R12-154	566-24-3-076	566-20-7-239	1R12-620
566-24-3-048	566-20-7-006	1R12-143	566-24-3-076	566-20-7-251	1R12-616
566-24-3-061	566-20-7-251	1R12-531	566-24-3-076	566-20-7-156	1R12-614
566-24-3-061	566-20-7-251	1R12-530	566-24-3-076	566-20-7-156	1R12-600
566-24-3-061	566-20-7-014	1R12-383	566-24-3-076	566-20-7-212	1R12-543
566-24-3-061	566-20-7-197	1R12-359	566-24-3-076	566-20-7-156	1R12-512
566-24-3-061	566-20-7-197	1R12-351	566-24-3-076	566-20-7-235	1R12-505
566-24-3-061	566-20-7-197	1R12-350	566-24-3-076	566-20-7-036	1R12-492
566-24-3-066	566-20-7-159	1R12-653	566-24-3-076	566-20-7-156	1R12-445
566-24-3-066	566-20-7-159	1R12-639	566-24-3-076	566-20-7-156	1R12-437
566-24-3-066	566-20-7-158	1R12-613	566-24-3-076	566-20-7-164	1R12-434
566-24-3-066	566-20-7-235	1R12-568	566-24-3-076	566-20-7-036	1R12-422
566-24-3-066	566-20-7-006	1R12-527	566-24-3-076	566-20-7-158	1R12-421
566-24-3-066	566-20-7-236	1R12-523	566-24-3-076	566-20-7-036	1R12-370
566-24-3-066	566-20-7-237	1R12-504	566-24-3-076	566-20-7-164	1R12-367
566-24-3-066	566-20-7-235	1R12-480	566-24-3-076	566-20-7-036	1R12-355
566-24-3-066	566-20-7-005	1R12-467	566-24-3-076	566-20-7-080	1R12-352
566-24-3-066	566-20-7-159	1R12-444	566-24-3-076	566-20-7-055	1R12-325
566-24-3-066	566-20-7-237	1R12-439	566-24-3-076	566-20-7-055	1R12-205
566-24-3-066	566-20-7-236	1R12-432	566-24-3-076	566-20-7-036-03	1R12-169
566-24-3-066	566-20-7-080	1R12-395	566-24-3-076	566-20-7-006	1R12-139
566-24-3-066	566-20-7-163	1R12-375	566-24-3-076	566-20-7-036	1R12-132
566-24-3-066	566-20-7-006	1R12-357	566-24-3-076	566-20-7-036	1R12-076
566-24-3-066	566-20-7-080	1R12-281	566-24-3-076	566-20-7-235	1R12-676
566-24-3-066	566-20-7-080	1R12-265	566-24-3-090	566-20-7-159	1R12-637
566-24-3-066	566-20-7-006	1R12-261	566-24-3-090	566-20-7-159	1R12-609
566-24-3-066	566-20-7-006	1R12-195	566-24-3-090	566-20-7-159	1R12-599
566-24-3-066	566-20-7-080	1R12-185	566-24-3-090	566-20-7-159	1R12-363
566-24-3-066	566-20-7-080	1R12-167	566-24-3-090	566-20-7-006	1R12-335
566-24-3-066	566-20-7-006	1R12-145	566-24-3-090	566-20-7-159	1R12-256
566-24-3-066	566-20-7-006	1R12-142	566-24-3-090	Not Included	1R12-158
566-24-3-066	Not Included	1R12-113	566-24-3-097	566-20-7-303	1R12-647
566-24-3-066	566-20-7-006	1R12-103	566-24-3-097	566-20-7-158	1R12-644
566-24-3-066	566-20-7-236	1R12-689	566-24-3-097	566-20-7-236	1R12-622
566-24-3-066	566-20-7-158	1R12-607	566-24-3-097	566-20-7-159	1R12-621
566-24-3-066	Not Included	1R12-162	566-24-3-097	566-20-7-235	1R12-532
566-24-3-066	566-207-006	1R12-208	566-24-3-097	566-20-7-237	1R12-498
566-24-3-067	566-20-7-238	1R12-571	566-24-3-097	566-20-7-235	1R12-481

*The prefixes ASC, ASD, AS3 OR AS4 may be used interchangeably with 566 and may appear on some flex members or pistons.

FLEX MEMBER INDEX (Cont.)

Flexible Member No.	Piston Number	Air Spring Number	Flexible Member No.	Piston Number	Air Spring Number
566-24-3-097	566-20-7-158	1R12-450	566-28-3-015	566-20-7-223	1R14-167
566-24-3-097	566-20-7-158	1R12-446	566-28-3-020	566-20-7-096	1R14-209
566-24-3-097	566-20-7-246	1R12-424	566-28-3-020	566-20-7-097	1R14-174
566-24-3-097	566-20-7-246	1R12-404	566-28-3-020	566-20-7-097	1R14-170
566-24-3-097	566-20-7-246	1R12-403	566-28-3-020	566-20-7-097	1R14-154
566-24-3-097	566-20-7-246	1R12-402	566-28-3-020	Not Included	1R14-060
566-24-3-097	566-20-7-079	1R12-274	566-28-3-020	566-20-7-097	1R14-045
566-24-3-108	566-20-7-322	1R12-603	566-28-3-020	Not Included	1R14-031
566-24-3-108	566-20-7-116	1R12-303	566-28-3-020	566-20-7-097	1R14-030
566-24-3-116	566-20-7-158	1R12-534	566-28-3-020	Not Included	1R14-025
566-24-3-117	566-20-7-299	1R12-580	566-28-3-020	566-20-7-097	1R14-019
566-24-3-120	566-20-7-079	1R12-631	566-28-3-021	566-20-7-276	1R14-218
566-25-3-097	566-20-7-303	1R12-615	566-28-3-021	566-20-7-327	1R14-215
566-26-3-015	566-20-7-084	1R13-070	566-28-3-021	566-20-7-276	1R14-177
566-26-3-043	566-20-7-080	1R13-117	566-28-3-021	566-20-7-097	1R14-160
566-26-3-044	566-20-7-006	1R13-116	566-28-3-021	566-20-7-096	1R14-159
566-26-3-044	566-20-7-006	1R13-115	566-28-3-021	566-20-7-189	1R14-141
566-26-3-050	566-20-7-106	1R13-138	566-28-3-021	566-20-7-096	1R14-137
566-26-3-050	566-20-7-127	1R13-124	566-28-3-021	566-20-7-096	1R14-130
566-26-3-051	566-20-7-124	1R13-182	566-28-3-021	566-20-7-217	1R14-124
566-26-3-051	566-20-7-124	1R13-181	566-28-3-021	566-20-7-097	1R14-115
566-26-3-051	566-20-7-106	1R13-155	566-28-3-021	566-20-7-188	1R14-106
566-26-3-051	566-20-7-036-03	1R13-075	566-28-3-021	566-20-7-080	1R14-101
566-26-3-051	566-20-7-036	1R13-053	566-28-3-021	Not Included	1R14-029
566-26-3-051	Not Included	1R13-049	566-28-3-021	566-20-7-096	1R14-028
566-26-3-051	566-20-7-096	1R13-047	566-28-3-021	Not Included	1R14-027
566-26-3-051	566-20-7-327	1R13-039	566-28-3-021	566-20-7-096	1R14-026
566-26-3-053	566-20-7-106	1R13-119	566-28-3-021	Not Included	1R14-024
566-26-3-054	566-20-7-334	1R13-120	566-28-3-021	566-20-7-096	1R14-018
566-26-3-055	566-20-7-230	1R13-130	566-28-3-024	566-20-7-050	1R14-112
566-26-3-056	566-20-7-231	1R13-133	566-28-3-030	566-20-7-181	1R14-113
566-26-3-068	566-20-7-325	1R13-118	566-28-3-031	566-20-7-181	1R14-127
566-26-3-069	566-20-7-334	1R13-151	566-28-3-042	566-20-7-334	1R14-175
566-26-3-071	566-20-7-235	1R13-208	566-28-3-042	566-20-7-152	1R14-172
566-26-3-071	566-20-7-237	1R13-153	566-28-3-043	566-20-7-304	1R14-182
566-26-3-071	566-20-7-235	1R13-152	566-28-3-044	566-20-7-152	1R14-190
566-26-3-072	Not Included	1R13-048	566-28-3-044	566-20-7-152	1R14-183
566-26-3-072	566-20-7-097	1R13-038	566-30-3-001	566-20-7-152	1R15-001
566-26-3-072	566-20-7-097	1R13-216	578-91-3-301		1B12-313
566-26-3-073	566-20-7-154	1R13-159	578-91-3-301		1B12-306
566-26-3-078	566-20-7-152	1R13-189	578-91-3-301		1B12-305
566-26-3-078	566-20-7-314	1R13-188	578-91-3-301		1B12-301
566-26-3-078	566-20-7-152	1R13-179	578-91-3-351		1B14-351
566-26-3-078	566-20-7-154	1R13-177	578-91-3-351		1B14-350
566-26-3-078	566-20-7-154	1R13-176	578-91-3-351		1B14-373
566-26-3-078	566-20-7-152	1R13-174	578-91-3-352		1B14-358
566-26-3-081	566-20-7-106	1R13-210	578-92-3-202		2B9-245
566-26-3-081	566-20-7-106	1R13-207	578-92-3-202		2B9-244
566-26-3-081	566-20-7-296	1R13-109	578-92-3-202		2B9-240
566-26-3-081	566-20-7-296	1R13-097	578-92-3-202		2B9-230
566-28-3-015	566-20-7-152	1R14-171	578-92-3-202		2B9-225
566-28-3-015	566-20-7-334-03	1R14-147	578-92-3-206		2B9-270
566-28-3-015	566-20-7-334	1R14-108	578-92-3-206		2B9-265
566-28-3-015	566-20-7-334-03	1R14-094	578-92-3-206		2B9-255
566-28-3-015	566-20-7-334	1R14-052	578-92-3-206		2B9-254
566-28-3-015	566-20-7-334-03	1R14-042	578-92-3-206		2B9-253
566-28-3-015	566-20-7-334	1R14-039	578-92-3-206		2B9-252
566-28-3-015	566-20-7-334	1R14-038	578-92-3-206		2B9-251
566-28-3-015	566-20-7-334	1R14-037	578-92-3-206		2B9-250
566-28-3-015	566-20-7-334	1R14-216	578-92-3-206		2B9-218
566-28-3-015	566-20-7-230	1R14-205	578-923-208		2B9-607

*The prefixes ASC, ASD, AS3 OR AS4 may be used interchangeably with 566 and may appear on some flex members or pistons.

FLEX MEMBER INDEX (Cont.)

Flexible Member No.	Piston Number	Air Spring Number	Flexible Member No.	Piston Number	Air Spring Number
578-92-3-208		2B9-266	578-93-3-100		3B12-324
578-923-211		2B9-611	578-93-3-100		3B12-319
578-923-211		2B9-606	578-93-3-100		3B12-315
578-923-211		2B9-296	578-93-3-100		3B12-312
578-9-23-211		2B9-614	578-93-3-100		3B12-310
578-92-3-211		2B9-288	578-93-3-100		3B12-305
578-92-3-211		2B9-280	578-93-3-100		3B12-304
578-92-3-211		2B9-246	578-93-3-100		3B12-303
578-92-3-211		2B9-239	578-93-3-100		3B12-301
578-92-3-211		2B9-229	578-93-3-100		3B12-300
578-92-3-250		2B10-226	578-93-3-100		3B12-342
578-92-3-309		2B12-463	578-93-3-103		3B12-347
578-92-3-309		2B12-432	578-93-3-103		3B12-326
578-92-3-309		2B12-429	578-93-3-103		3B12-325
578-92-3-309		2B12-427	578-93-3-103		3B12-323
578-92-3-309		2B12-426	578-93-3-103		3B12-322
578-92-3-309		2B12-425	578-93-3-105		3B12-416
578-92-3-309		2B12-424	578-93-3-105		3B12-415
578-92-3-309		2B12-412	578-93-3-335		3B14-452
578-92-3-309		2B12-411	578-93-3-335		3B14-451
578-92-3-309		2B12-410	578-93-3-350		3B14-367
578-92-3-309		2B12-406	578-93-3-350		3B14-365
578-92-3-309		2B12-340	578-93-3-350		3B14-364
578-92-3-309		2B12-320	578-93-3-350		3B14-361
578-92-3-309		2B12-319	578-93-3-350		3B14-360
578-92-3-309		2B12-318	578-93-3-350		3B14-359
578-92-3-309		2B12-313	578-93-3-350		3B14-356
578-92-3-309		2B12-309	578-93-3-350		3B14-354
578-92-3-309		2B12-307	578-93-3-350		3B14-351
578-92-3-309		2B12-304	579-91-3-532		1B8-564
578-92-3-309		2B12-300	579-92-3-202		2B9-216
578-92-3-310		2B12-446	579-92-3-202		2B9-210
578-92-3-310		2B12-434	579-92-3-202		2B9-206
578-92-3-310		2B12-428	579-92-3-202		2B9-201
578-92-3-310		2B12-402	579-92-3-202		2B9-200
578-92-3-310		2B12-324	579-923-510		2B6-530
578-92-3-310		2B12-317	579-92-3-515		2B6-535
578-92-3-310		2B12-305	579-923-525		2B7-542
578-92-3-315		2B12-440	579-92-3-526		2B7-548
578-92-3-315		2B12-416	579-92-3-530		2B8-550
578-92-3-315		2B12-346			
578-92-3-315		2B12-345			
578-92-3-353		2B14-473			
578-92-3-353		2B14-367			
578-92-3-353		2B14-366			
578-92-3-353		2B14-360			
578-92-3-353		2B14-359			
578-92-3-353		2B14-356			
578-92-3-353		2B14-355			
578-92-3-353		2B14-354			
578-923-356		2B14-479			
578-92-3-356		2B14-476			
578-92-3-356		2B14-470			
578-92-3-356		2B14-462			
578-92-3-356		2B14-383			
578-92-3-356		2B14-365			
578-92-3-356		2B14-363			
578-93-3-100		3B12-338			
578-93-3-100		3B12-335			
578-93-3-100		3B12-329			
578-93-3-100		3B12-328			

*The prefixes ASC, ASD, AS3 OR AS4 may be used interchangeably with 566 and may appear on some flex members or pistons.

Firestone By Flex Member

Firestone Flex Member No.	Firestone No.	Air Spring Number	Firestone Flex Member No.	Firestone No.	Air Spring Number
113B-1	7112	1B14-358	1T15M-0	9077	1R12-359
1T15S-6	9043	1R10-089	1T15M-11	9320	1R12-363
1T15LP-5	9293	1R10-120	1T15MT-6	9466	1R12-365
1T15LP-5	9291	1R10-122	1T15MLW-7	8944	1R12-366
1T15S-6	9073	1R11-018	1T15MT-3	9640	1R12-367
1T15L-1.5	9422	1R11-028	1T15M-4	9070	1R12-370
1T15L-2	9447	1R11-066	1T15MW-10	9265	1R12-375
1T15L-2	9448	1R11-150	1T15M-9	9203	1R12-395
1T15L-2	9457	1R11-151	1T15M-6	9296	1R12-400
1T15L-2	9459	1R11-152	1T15MT-8	9371	1R12-401
1T15TM-1	5766	1R11-161	1T15MT-8	9297	1R12-402
1T15LP-5	9295	1R11-166	1T15MT-8	9373	1R12-403
1T15TM-1	9421	1R11-171	1T15MT-8	9375	1R12-404
1T15L-4	8919	1R11-191	1T15M-4	8802	1R12-434
1T15L-2	9376	1R11-200	1T15M-6	8924	1R12-436
1T15L-2	9377	1R11-201	1T15M-4	9797	1R12-437
1T15L-2	9378	1R11-202	1T15M-4	8805	1R12-438
1T15L-2	9387	1R11-203	1T15M-9	9346	1R12-439
1T15L-2	8900	1R11-204	1T15M-6	9362	1R12-441
1T15L-2	9476	1R11-205	1T15M-4	8806	1R12-445
1T15LA-1	9617	1R11-219	1T15M-9	9245	1R12-446
1T15LA-0	9618	1R11-220	1T15M-9	9243	1R12-480
1T15LA-1	9622	1R11-221	1T15M-8	9923	1R12-481
1T15LA-0	9625	1R11-222	1T15V-8	9473	1R12-484
1T15MJ-6	9098	1R12-014	1T15V-8	9471	1R12-485
1T15MJ-6	9098	1R12-047	1T15V-8	9473	1R12-486
1T15M-6	9083	1R12-066	1T15M-2	9366	1R12-487
1T15M-4	9069	1R12-069	1T15M-7.5	9921	1R12-502
1T15M-6	9213	1R12-090	1T15V-8	9471	1R12-504
1T15M-6	9082	1R12-092	1T15M-2	9325	1R12-505
1T15M-0	9039	1R12-095	1T15M-2	8204	1R12-508
1T15M-9	9101	1R12-103	1T15M-2	9078	1R12-512
1T15M-6	9227	1R12-130	1T15M-7.5	9935	1R12-532
1T15M-2	9302	1R12-132	1T15MT-8	9648	1R12-538
1T15M-9	9241	1R12-142	1T15V-8	9471	1R12-552
1T15M-6	9392	1R12-143	1T15V-8	9472	1R12-553
1T15M-9	9238	1R12-145	1T15V-8	9470	1R12-554
1T15M-6	9096	1R12-155	1T15M-0	8961	1R12-555
1T15M-9	9192	1R12-167	1T15M-0	8964	1R12-556
1T15LC-2.5	9379	1R12-178	1T15M-0	8976	1R12-557
1T15M-6	9219	1R12-182	1T15M-0	8986	1R12-558
1T15M-6	9223	1R12-188	1T15M-0	9029	1R12-559
1T15M-9	9349	1R12-195	1T15M-0	9308	1R12-560
1T15LC-2.5	9566	1R12-204	1T15M-0	9332	1R12-561
1T15LC-4.5	9568	1R12-205	1T15M-2	8197	1R12-562
1T15M-6	9193	1R12-220	1T15M-2	8934	1R12-563
1T15M-11	9321	1R12-256	1T15M-6	9026	1R12-567
1T19F-5	9204	1R12-265	1T15M-9	8852	1R12-568
1T15MT-8	9287	1R12-274	1T15M-2	9365	1R12-571
1T15M-9	9130	1R12-281	1T15M-11	9370	1R12-580
1T15ZR-6	9780	1R12-303	1T19L-11	9122	1R13-038
1T15M-2	9053	1R12-309	1T19L-7	9121	1R13-039
1T15LC-2.5	9565	1R12-324	1T15V-11	9250	1R13-115
1T15LC-4.5	9567	1R12-325	1T15V-11	9252	1R13-116
1T15M-0	9031	1R12-350	1T15V-8	9275	1R13-117
1T15M-0	9033	1R12-351	1T15VLY-10.5	9580	1R13-118
1T15M-4	9010	1R12-352	1T15VM-4.0	9270	1R13-119
1T15M-2	9127	1R12-355	1T19F-5	9218	1R13-120
1T15M-6	9194	1R12-356	1T17CL-5	8710	1R13-124
1T15M-9	9348	1R12-357	1T17BB-2	8729	1R13-130
1T15M-6	9096	1R12-358	1T17B-11	8748	1R13-152

*The prefixes ASC, ASD, AS3 OR AS4 may be used interchangeably with 566 and may appear on some flex members or pistons.



Firestone ByFlex Member (Cont.)

Firestone Flex Member No.	Firestone No.	Air Spring Number	Firestone Flex Member No.	Firestone No.	Air Spring Number
1T17B-11	8749	1R13-153	21	7123	2B14-367
1T17CA-5	8709	1R13-159	22	7424	2B12-300
1T17CA-6.5	8713	1R13-176	22	7408	2B12-307
1T17CA-6.5	8708	1R13-177	22	7400	2B12-309
1T19L-7	9149	1R14-018	22	7405	2B12-313
1T19F-11	9156	1R14-019	22	7185	2B12-318
1T19F-7	9148	1R14-026	22	7409	2B12-319
1T19L-7	9177	1R14-028	22	7401	2B12-320
1T19L-11	9158	1R14-030	22	7410	2B12-406
1T19F-5	9215	1R14-037	22	7404	2B12-410
1T19F-5	9200	1R14-038	22	7181	2B12-411
1T19J-7	8050	1R14-039	22	7183	2B12-412
1T19J-6	8052	1R14-042	22	7180	2B12-425
1T19L-11	9122	1R14-045	22	7406	2B12-426
1T19F-12	5505	1R14-113	22	7429	2B12-427
1T19F-7	9961	1R14-115	22	7423	2B12-432
1T19F-14	9264	1R14-127	26	7325	2B8-550
1T19F-9	9134	1R14-137	38	8008	3B12-300
1T19J-6	8053	1R14-147	38	8010	3B12-301
1T19F-7	9164	1R14-159	38	8018	3B12-303
1T19F-7	9144	1R14-160	38	8006	3B12-304
1T19FC-6	8091	1R14-171	38	8027	3B12-310
1T19F-12	5503	1R14-174	38	8033	3B12-312
1T14F-4	5406	1R9-038	38	8032	3B12-319
1T14C-1		1R9-065	38	7994	3B12-328
1T14F-4		1R9-070	38	7995	3B12-329
22-1.5	7443	2B12-305	38	7996	3B12-335
22-1.5	7447	2B12-324	113	7103	1B14-350
228-1.5	7545	2B12-345	113	7105	1B14-351
228-1.5	7550	2B12-346	257	7795	2B10-226
228-1.5	7446	2B12-402	313	7808	3B14-354
22-1.5	7444	2B12-416	313	7838	3B14-356
22-1.5	7473	2B12-428	313	7839	3B14-359
22-1.5	7472	2B12-434	313	7848	3B14-360
228-1.5	7555	2B12-440	313	7847	3B14-367
22-1.5	7444	2B12-446	333	7846	3B14-451
21-2	6801	2B14-365	333	7850	3B14-452
21-2	6803	2B14-366			
233-2	7557	2B14-383			
20-2	6927	2B9-218			
20-2	6943	2B9-250			
20-2	6948	2B9-251			
20-2	6944	2B9-252			
20-2	6945	2B9-253			
20-2	6946	2B9-254			
20-2	6947	2B9-255			
19	7009	1B12-301			
20	6910	2B9-200			
20	6935	2B9-201			
20	6905	2B9-206			
20	6908	2B9-210			
20	6897	2B9-229			
20	6940	2B9-230			
20	6902	2B9-239			
20	6932	2B9-246			
20	6941	2B9-265			
21	7145	2B14-354			
21	7146	2B14-355			
21	7136	2B14-356			
21	7140	2B14-359			
21	7135	2B14-360			

*The prefixes ASC, ASD, AS3 OR AS4 may be used interchangeably with 566 and may appear on some flex members or pistons.

PISTON INDEX

Piston Number	Flexible Member No.	Air Spring Number	Piston Number	Flexible Member No.	Air Spring Number
566-20-7-240	566-20-3-022	1R10-019	566-20-7-287	566-22-3-021	1R11-221
Not Included	566-20-3-022	1R10-030	566-20-7-286	566-22-3-021	1R11-222
566-20-7-055	566-20-3-029	1R10-072	566-20-7-156	566-22-3-143	1R11-223
Not Included	566-20-3-021	1R10-085	566-20-7-308	566-22-3-073	1R11-224
566-20-7-240	566-20-3-021	1R10-087	566-20-7-253	566-22-3-057	1R11-225
566-20-7-240	566-20-3-021	1R10-089	566-20-7-124	566-22-3-049	1R11-232
566-20-7-120	566-20-3-021	1R10-090	566-20-7-253	566-22-3-143	1R11-241
566-20-7-240	566-20-3-021	1R10-091	566-20-7-252	566-22-3-021	1R11-242
566-20-7-240	566-20-3-021	1R10-099	566-20-7-120	566-22-3-143	1R11-243
566-20-7-150	566-20-3-027	1R10-101	566-20-7-079	566-22-3-079	1R11-244
566-20-7-240	566-20-3-021	1R10-105	566-20-7-156	566-22-3-084	1R11-249
566-20-7-120	566-20-3-021	1R10-108	566-20-7-235	566-22-3-042	1R11-252
566-20-7-077-	566-20-3-021	1R10-109	566-20-7-287	566-22-3-021	1R11-268
566-20-7-240	566-20-3-021	1R10-118	566-20-7-011	566-24-3-019	1R12-014
566-20-7-240	566-20-3-021	1R10-120	566-20-7-079	566-24-3-024	1R12-028
566-20-7-237	566-20-3-021	1R10-122	566-20-7-011	566-24-3-019	1R12-047
566-20-7-240	566-20-3-021	1R10-127	566-20-7-080	566-24-3-038	1R12-066
566-20-7-240	566-20-3-021	1R10-133	566-20-7-235	566-24-3-038	1R12-069
566-20-7-240	566-20-3-023	1R10-137	566-20-7-036	566-24-3-076	1R12-076
566-20-7-079	566-22-3-006	1R11-018	566-20-7-079	566-24-3-038	1R12-090
566-20-7-014	566-22-3-021	1R11-028	566-20-7-080	566-24-3-038	1R12-092
566-20-7-036	566-22-3-143	1R11-039	Not Included	566-24-3-038	1R12-093
566-20-7-077-	566-22-3-143	1R11-045	566-20-7-014	566-24-3-067	1R12-095
566-20-7-014	566-22-3-021	1R11-047	Not Included	566-24-3-067	1R12-097
566-20-7-055	566-22-3-021	1R11-066	566-20-7-006	566-24-3-066	1R12-103
566-20-7-055	566-22-3-028	1R11-075	Not Included	566-24-3-066	1R12-113
566-20-7-120	566-22-3-143	1R11-088	566-20-7-240	566-24-3-024	1R12-127
566-20-7-079	566-22-3-143	1R11-090	566-20-7-080	566-24-3-038	1R12-130
566-20-7-240	566-22-3-143	1R11-094	566-20-7-036	566-24-3-076	1R12-132
566-20-7-079	566-22-3-044	1R11-097	566-20-7-006	566-24-3-076	1R12-139
566-20-7-183	566-22-3-051	1R11-115	566-20-7-006	566-24-3-066	1R12-142
566-20-7-156	566-22-3-143	1R11-121	566-20-7-006	566-24-3-048	1R12-143
566-20-7-124	566-22-3-049	1R11-130	566-20-7-006	566-24-3-066	1R12-145
566-20-7-240	566-22-3-143	1R11-143	566-20-7-120	566-24-3-048	1R12-154
566-20-7-240	566-22-3-143	1R11-147	566-20-7-080	566-24-3-038	1R12-155
566-20-7-239	566-22-3-143	1R11-149	566-20-7-055	566-24-3-067	1R12-156
566-20-7-055	566-22-3-021	1R11-150	Not Included	566-24-3-090	1R12-158
566-20-7-055	566-22-3-021	1R11-151	Not Included	566-24-3-066	1R12-162
566-20-7-055	566-22-3-021	1R11-152	566-20-7-080	566-24-3-066	1R12-167
566-20-7-014	566-22-3-021	1R11-159	566-20-7-036	566-24-3-076	1R12-169
566-20-7-150	566-22-3-057	1R11-161	566-20-7-055	566-24-3-067	1R12-178
566-20-7-014	566-22-3-021	1R11-162	566-20-7-079	566-24-3-038	1R12-182
566-20-7-235	566-22-3-143	1R11-166	566-20-7-080	566-24-3-066	1R12-185
566-20-7-250	566-22-3-143	1R11-169	566-20-7-079	566-24-3-038	1R12-188
566-20-7-240	566-22-3-143	1R11-170	566-20-7-006	566-24-3-066	1R12-195
566-20-7-150	566-22-3-057	1R11-171	566-20-7-055	566-24-3-067	1R12-204
566-20-7-257	566-22-3-060	1R11-175	566-20-7-055	566-24-3-076	1R12-205
566-20-7-209	566-22-3-143	1R11-178	566-207-006	566-24-3-066	1R12-208
566-20-7-209	566-22-3-143	1R11-179	566-20-7-120	566-24-3-048	1R12-217
566-20-7-240	566-22-3-049	1R11-189	566-20-7-080	566-24-3-038	1R12-220
566-20-7-239	566-22-3-143	1R11-191	566-20-7-159	566-24-3-090	1R12-256
566-20-7-252	566-22-3-021	1R11-200	566-20-7-006	566-24-3-066	1R12-261
566-20-7-252	566-22-3-021	1R11-201	566-20-7-080	566-24-3-066	1R12-265
566-20-7-252	566-22-3-021	1R11-202	566-20-7-079	566-24-3-097	1R12-274
566-20-7-251	566-22-3-021	1R11-203	566-20-7-080	566-24-3-066	1R12-281
566-20-7-253	566-22-3-021	1R11-204	566-20-7-240	566-24-3-048	1R12-284
566-20-7-253	566-22-3-021	1R11-205	566-20-7-080	566-24-3-038	1R12-285
566-20-7-257	566-22-3-068	1R11-216	566-20-7-120	566-24-3-048	1R12-288
566-20-7-287	566-22-3-021	1R11-219	566-20-7-116	566-24-3-108	1R12-303
566-20-7-286	566-22-3-021	1R11-220	566-20-7-240	566-24-3-048	1R12-304

*The prefixes ASC, ASD, AS3 OR AS4 may be used interchangeably with 566 and may appear on some flex members or pistons.

PISTON INDEX (Cont.)

Piston Number	Flexible Member No.	Air Spring Number	Piston Number	Flexible Member No.	Air Spring Number
566-20-7-164	566-24-3-067	1R12-309	566-20-7-237	566-24-3-066	1R12-504
566-20-7-055	566-24-3-067	1R12-324	566-20-7-235	566-24-3-076	1R12-505
566-20-7-055	566-24-3-076	1R12-325	566-20-7-251	566-24-3-067	1R12-508
566-20-7-006	566-24-3-090	1R12-335	566-20-7-005	566-24-3-038	1R12-509
566-20-7-197	566-24-3-061	1R12-350	566-20-7-240	566-24-3-048	1R12-511
566-20-7-197	566-24-3-061	1R12-351	566-20-7-156	566-24-3-076	1R12-512
566-20-7-080	566-24-3-076	1R12-352	566-20-7-236	566-24-3-066	1R12-523
566-20-7-036	566-24-3-076	1R12-355	566-20-7-006	566-24-3-066	1R12-527
566-20-7-080	566-24-3-038	1R12-356	566-20-7-251	566-24-3-061	1R12-530
566-20-7-006	566-24-3-066	1R12-357	566-20-7-251	566-24-3-061	1R12-531
566-20-7-080	566-24-3-038	1R12-358	566-20-7-235	566-24-3-097	1R12-532
566-20-7-197	566-24-3-061	1R12-359	566-20-7-158	566-24-3-116	1R12-534
566-20-7-159	566-24-3-090	1R12-363	566-20-7-236	566-24-3-038	1R12-538
566-20-7-079	566-24-3-038	1R12-365	566-20-7-209	566-24-3-038	1R12-541
566-20-7-163	566-24-3-038	1R12-366	566-20-7-212	566-24-3-076	1R12-543
566-20-7-164	566-24-3-076	1R12-367	566-20-7-215	566-24-3-038	1R12-552
566-20-7-079	566-24-3-038	1R12-369	566-20-7-213	566-24-3-038	1R12-553
566-20-7-036	566-24-3-076	1R12-370	566-20-7-214	566-24-3-038	1R12-554
566-20-7-163	566-24-3-066	1R12-375	566-20-7-253	566-24-3-067	1R12-555
566-20-7-014	566-24-3-061	1R12-383	566-20-7-252	566-24-3-067	1R12-556
Not Included	566-24-3-038	1R12-394	566-20-7-252	566-24-3-067	1R12-557
566-20-7-080	566-24-3-066	1R12-395	566-20-7-252	566-24-3-067	1R12-558
566-20-7-240	566-24-3-038	1R12-396	566-20-7-252	566-24-3-067	1R12-559
566-20-7-246	566-24-3-038	1R12-400	566-20-7-253	566-24-3-067	1R12-560
566-20-7-221	566-24-3-038	1R12-401	566-20-7-253	566-24-3-067	1R12-561
566-20-7-246	566-24-3-097	1R12-402	566-20-7-251	566-24-3-067	1R12-562
566-20-7-246	566-24-3-097	1R12-403	566-20-7-252	566-24-3-067	1R12-563
566-20-7-246	566-24-3-097	1R12-404	566-20-7-235	566-24-3-038	1R12-567
566-20-7-233	566-24-3-038	1R12-419	566-20-7-235	566-24-3-066	1R12-568
566-20-7-158	566-24-3-076	1R12-421	566-20-7-238	566-24-3-067	1R12-571
566-20-7-036	566-24-3-076	1R12-422	566-20-7-159	566-24-3-038	1R12-576
566-20-7-246	566-24-3-038	1R12-423	566-20-7-299	566-24-3-117	1R12-580
566-20-7-246	566-24-3-097	1R12-424	566-20-7-158	566-24-3-038	1R12-584
566-20-7-236	566-24-3-066	1R12-432	566-20-7-237	566-24-3-038	1R12-586
566-20-7-164	566-24-3-076	1R12-434	566-20-7-159	566-24-3-090	1R12-599
566-20-7-014	566-24-3-067	1R12-435	566-20-7-156	566-24-3-076	1R12-600
566-20-7-158	566-24-3-038	1R12-436	566-20-7-322	566-24-3-108	1R12-603
566-20-7-156	566-24-3-076	1R12-437	566-20-7-158	566-24-3-066	1R12-607
566-20-7-158	566-24-3-038	1R12-438	566-20-7-159	566-24-3-090	1R12-609
566-20-7-237	566-24-3-066	1R12-439	566-20-7-158	566-24-3-066	1R12-613
566-20-7-235	566-24-3-038	1R12-441	566-20-7-156	566-24-3-076	1R12-614
566-20-7-159	566-24-3-066	1R12-444	566-20-7-303	566-25-3-097	1R12-615
566-20-7-156	566-24-3-076	1R12-445	566-20-7-251	566-24-3-076	1R12-616
566-20-7-158	566-24-3-097	1R12-446	566-20-7-036	566-24-3-038	1R12-617
566-20-7-158	566-24-3-097	1R12-450	566-20-7-239	566-24-3-076	1R12-620
566-20-7-079	566-24-3-038	1R12-454	566-20-7-159	566-24-3-097	1R12-621
566-20-7-246	566-24-3-038	1R12-462	566-20-7-236	566-24-3-097	1R12-622
566-20-7-014	566-24-3-067	1R12-465	566-20-7-079	566-24-3-120	1R12-631
566-20-7-005	566-24-3-066	1R12-467	566-20-7-156	566-24-3-076	1R12-636
566-20-7-235	566-24-3-066	1R12-480	566-20-7-159	566-24-3-090	1R12-637
566-20-7-235	566-24-3-097	1R12-481	566-20-7-159	566-24-3-066	1R12-639
566-20-7-215	566-24-3-038	1R12-484	566-20-7-238	566-24-3-038	1R12-640
566-20-7-215	566-24-3-038	1R12-485	566-20-7-158	566-24-3-097	1R12-644
566-20-7-215	566-24-3-038	1R12-486	566-20-7-303	566-24-3-097	1R12-647
566-20-7-239	566-24-3-067	1R12-487	566-20-7-239	566-24-3-076	1R12-648
566-20-7-036	566-24-3-076	1R12-492	566-20-7-159	566-24-3-066	1R12-653
566-20-7-036	566-24-3-038	1R12-494	566-20-7-158	566-24-3-076	1R12-655
566-20-7-237	566-24-3-097	1R12-498	566-20-7-053	566-24-3-038	1R12-669
566-20-7-238	566-24-3-038	1R12-499	566-20-7-235	566-24-3-076	1R12-676
566-20-7-235	566-24-3-038	1R12-502	566-20-7-236	566-24-3-066	1R12-689

*The prefixes ASC, ASD, AS3 OR AS4 may be used interchangeably with 566 and may appear on some flex members or pistons.

PISTON INDEX (Cont.)

Piston Number	Flexible Member No.	Air Spring Number	Piston Number	Flexible Member No.	Air Spring Number
566-20-7-097	566-26-3-072	1R13-038	566-20-7-097	566-28-3-021	1R14-115
566-20-7-327	566-26-3-051	1R13-039	566-20-7-217	566-28-3-021	1R14-124
566-20-7-096	566-26-3-051	1R13-047	566-20-7-181	566-28-3-031	1R14-127
Not Included	566-26-3-072	1R13-048	566-20-7-096	566-28-3-021	1R14-130
Not Included	566-26-3-051	1R13-049	566-20-7-096	566-28-3-021	1R14-137
566-20-7-036	566-26-3-051	1R13-053	566-20-7-189	566-28-3-021	1R14-141
566-20-7-084	566-26-3-015	1R13-070	566-20-7-334	566-28-3-015	1R14-147
566-20-7-036	566-26-3-051	1R13-075	566-20-7-097	566-28-3-020	1R14-154
566-20-7-296	566-26-3-081	1R13-097	566-20-7-096	566-28-3-021	1R14-159
566-20-7-296	566-26-3-081	1R13-109	566-20-7-097	566-28-3-021	1R14-160
566-20-7-006	566-26-3-044	1R13-115	566-20-7-223	566-28-3-015	1R14-167
566-20-7-006	566-26-3-044	1R13-116	566-20-7-097	566-28-3-020	1R14-170
566-20-7-080	566-26-3-043	1R13-117	566-20-7-152	566-28-3-015	1R14-171
566-20-7-325	566-26-3-068	1R13-118	566-20-7-152	566-28-3-042	1R14-172
566-20-7-106	566-26-3-053	1R13-119	566-20-7-097	566-28-3-020	1R14-174
566-20-7-334	566-26-3-054	1R13-120	566-20-7-334	566-28-3-042	1R14-175
566-20-7-127	566-26-3-050	1R13-124	566-20-7-276	566-28-3-021	1R14-177
566-20-7-230	566-26-3-055	1R13-130	566-20-7-304	566-28-3-043	1R14-182
566-20-7-231	566-26-3-056	1R13-133	566-20-7-152	566-28-3-044	1R14-183
566-20-7-106	566-26-3-050	1R13-138	566-20-7-152	566-28-3-044	1R14-190
566-20-7-334	566-26-3-069	1R13-151	566-20-7-230	566-28-3-015	1R14-205
566-20-7-235	566-26-3-071	1R13-152	566-20-7-096	566-28-3-020	1R14-209
566-20-7-237	566-26-3-071	1R13-153	566-20-7-327	566-28-3-021	1R14-215
566-20-7-106	566-26-3-051	1R13-155	566-20-7-334	566-28-3-015	1R14-216
566-20-7-154	566-26-3-073	1R13-159	566-20-7-276	566-28-3-021	1R14-218
566-20-7-152	566-26-3-078	1R13-174	566-20-7-152	566-30-3-001	1R15-001
566-20-7-154	566-26-3-078	1R13-176	566-16-7-021	566-16-3-007	1R8-034
566-20-7-154	566-26-3-078	1R13-177	566-16-7-000	566-16-3-007	1R8-036
566-20-7-152	566-26-3-078	1R13-179	566-16-7-021	566-18-3-004	1R9-003
566-20-7-124	566-26-3-051	1R13-181	566-16-7-017	566-18-3-010	1R9-025
566-20-7-124	566-26-3-051	1R13-182	566-16-7-017	566-18-3-010	1R9-038
566-20-7-314	566-26-3-078	1R13-188	Not Included	566-18-3-004	1R9-047
566-20-7-152	566-26-3-078	1R13-189	566-16-7-021	566-18-3-004	1R9-053
566-20-7-106	566-26-3-081	1R13-207	566-16-7-000	566-18-3-004	1R9-054
566-20-7-235	566-26-3-071	1R13-208	566-16-7-000	566-18-3-004	1R9-056
566-20-7-106	566-26-3-081	1R13-210	566-16-7-009	566-18-3-003	1R9-065
566-20-7-097	566-26-3-072	1R13-216	566-16-7-021	566-18-3-004	1R9-070
566-20-7-096	566-28-3-021	1R14-018	ASB-06-7-014		1S3-011
566-20-7-097	566-28-3-020	1R14-019	ASC-06-7-017		1S3-013
Not Included	566-28-3-021	1R14-024	ASC-08-7-194		1S4.5-073
Not Included	566-28-3-020	1R14-025	ASC-08-7-194		1S4.5-107
566-20-7-096	566-28-3-021	1R14-026	579-08-7-219		1S4.5-113
Not Included	566-28-3-021	1R14-027	ASC-08-7-157		1S4.5-121
566-20-7-096	566-28-3-021	1R14-028	ASC-08-7-157		1S4.5-179
Not Included	566-28-3-021	1R14-029	ASC-08-7-139		1S4-007
566-20-7-097	566-28-3-020	1R14-030	ASC-08-7-005		1S4-008
Not Included	566-28-3-020	1R14-031	ASC-08-7-137		1S4-016
566-20-7-334	566-28-3-015	1R14-037	ASC-08-7-093		1S4-030
566-20-7-334	566-28-3-015	1R14-038	ASC-08-7-163		1S4-035
566-20-7-334	566-28-3-015	1R14-039	ASC-08-7-219		1S4-042
566-20-7-334	566-28-3-015	1R14-042	ASC-08-7-194		1S4-044
566-20-7-097	566-28-3-020	1R14-045	ASC-08-7-194		1S4-056
566-20-7-334	566-28-3-015	1R14-052	ASC-08-7-139		1S4-058
Not Included	566-28-3-020	1R14-060	ASC-08-7-137		1S4-067
566-20-7-334	566-28-3-015	1R14-094	ASC-08-7-134		1S4-074
566-20-7-080	566-28-3-021	1R14-101	ASC-08-7-157		1S4-123
566-20-7-188	566-28-3-021	1R14-106	ASC-08-7-137		1S4-173
566-20-7-334	566-28-3-015	1R14-108	ASC-08-7-157		1S4-175
566-20-7-050	566-28-3-024	1R14-112	ASC-08-7-005		1S5-005
566-20-7-181	566-28-3-030	1R14-113	ASC-08-7-005		1S5-006

*The prefixes ASC, ASD, AS3 OR AS4 may be used interchangeably with 566 and may appear on some flex members or pistons.

PISTON INDEX (Cont.)

Piston Number	Flexible Member No.	Air Spring Number	Piston Number	Flexible Member No.	Air Spring Number
ASC-08-7-139		1S5-010			
ASC-08-7-163		1S5-032			
ASC-08-7-194		1S5-038			
ASC-08-7-137		1S5-040			
ASC-08-7-139		1S5-045			
ASC-08-7-194		1S5-055			
579-08-7-157		1S5-057			
ASC-08-7-219		1S5-060			
ASC-08-7-194		1S5-061			
ASB-08-7-134		1S5-070			
ASC-08-7-219		1S5-072			
ASC-08-7-194		1S5-120			
ASC-08-7-213		1S5-122			
ASC-08-7-157		1S5-133			
ASC-08-7-157		1S5-135			
579-08-7-137		1S5-146			
ASC-08-7-219		1S5-152			
ASC-08-7-213		1S5-154			
ASC-08-7-137		1S5-164			
ASC-08-7-137		1S5-173			
ASC-08-7-232		1S5-174			
ASB-08-7-079		1S6-023			
ASC-08-7-215		1S6-025			
ASC-08-7-223		1S6-026			
ASC-08-7-215		1S6-031			
ASC-08-7-215		1S6-033			
ASC-08-7-215		1S6-046			
ASC-08-7-215		1S6-055			

*The prefixes ASC, ASD, AS3 OR AS4 may be used interchangeably with 566 and may appear on some flex members or pistons.

TERMS & CONDITIONS OF SALE

THE INFORMATION HEREIN CONTAINED CONSTITUTES A CONFIRMATION OF CUSTOMER'S ORDER OR A CONFIRMATION OF CHANGE TO CUSTOMER'S ORDER, AS APPLICABLE (COLLECTIVELY "CONFIRMATION") AND WHICH CONFIRMATION IS EFFECTIVE UPON VEYANCE'S DISPATCH OF THIS CONFIRMATION. ANY PRIOR RECEIPT BY CUSTOMER FROM ANY OTHER SOURCE OF ALL OR PART OF THE INFORMATION HEREIN IS FOR INFORMATIONAL PURPOSES ONLY AND DOES NOT CONSTITUTE A LEGALLY BINDING CONFIRMATION. THIS CONFIRMATION IS EXPRESSLY MADE SUBJECT TO AND IS STRICTLY LIMITED TO THE TERMS AND CONDITIONS OF SALE STATED HEREIN AND ANY INCONSISTENT TERMS OR CONDITIONS APPEARING ON CUSTOMER'S ORDER ARE SPECIFICALLY OBJECTED TO AND DISCLAIMED. IN ANY COMMUNICATION WITH VEYANCE REGARDING THIS ORDER, PLEASE REFER TO VEYANCE'S DOCUMENT OR ORDER CONFIRMATION NUMBER.

(1) This Confirmation and any distributor's agreement, if any, between Customer and Veyance or a Veyance affiliate, together with any specifications, schedules, exhibits, riders, or other writings which may be annexed hereto or provided for hereunder and by reference made a part hereof (collectively, the "Agreement"), sets forth the complete and final agreement between Veyance and Customer in respect of the subject matter hereof, and supersedes all prior understandings, assurances, and Customer's order form, if any. **THE AGREEMENT CONTAINS THE ENTIRE UNDERSTANDING BETWEEN CUSTOMER AND VEYANCE AND NO OTHER REPRESENTATION OR INDUCEMENT, ORAL OR WRITTEN, HAS BEEN MADE WHICH IS NOT SET FORTH HEREIN. EXCEPT FOR THE WARRANTIES AND REPRESENTATIONS, IF ANY, SET FORTH IN THE AGREEMENT, NO OTHER STATEMENT, WARRANTY, REPRESENTATION OR INFORMATION, ORAL OR WRITTEN, SHALL BE LEGALLY BINDING UPON VEYANCE OR SHALL BE THE BASIS FOR RELIANCE BY CUSTOMER. CUSTOMER DOES NOT RELY AND IS NOT RELYING UPON ANY ORAL OR WRITTEN STATEMENT, WARRANTY OR REPRESENTATION OF VEYANCE, ITS EMPLOYEES, AGENTS AND/OR REPRESENTATIVES NOT FULLY SET FORTH HEREIN.** No amendments or modifications of or supplements to the provisions of this Confirmation will be valid and binding upon Veyance unless such amendment, modification or supplement is mutually agreed to in writing and signed by an officer of Veyance and an authorized representative of Customer. In the event of any direct inconsistency between this Confirmation and the provisions in the other components of the Agreement, on the other side of this document or in any supplement attached hereto, any of which have been executed by a duly authorized representative of Veyance, the provision contained in the Agreement, on the other side of this document or in such supplement shall control.

(2) Product sold hereunder manufactured by Veyance meets agreed specifications according to established tests performed under controlled laboratory conditions and specific test requirements. These tests are not intended to reflect the performance of the product under actual conditions. Performance of the product as a component in a finished product may not necessarily meet the test requirements. Due to the number and variety of applications for which any product sold hereunder may be purchased and because Veyance has no control over (or knowledge of) the conditions under which the product may be used by others, **VEYANCE DOES NOT RECOMMEND SPECIFIC APPLICATIONS OR PRODUCT DESIGNS OR ASSUME RESPONSIBILITY FOR USE RESULTS OBTAINED OR SUITABILITY FOR SPECIFIC APPLICATIONS.** No statement contained herein shall be construed as a license to operate, or as a recommendation or inducement to infringe existing patents or as an endorsement of products of specific manufacturers or systems.

(3) **NO RELIANCE.** CUSTOMER ACKNOWLEDGES THE USE OF ITS OWN KNOWLEDGE, SKILL, JUDGMENT, EXPERTISE AND EXPERIENCE IN (i) the selection of the product and/or (ii) in the selection, provision, or designation of any specification or set of specifications for a product agreed upon by Customer and Veyance; and CUSTOMER ACKNOWLEDGES THAT CUSTOMER DOES NOT RELY AND IS NOT RELYING ON ANY ORAL OR WRITTEN STATEMENTS, REPRESENTATIONS, OR SAMPLES MADE OR PRESENTED BY VEYANCE, ITS EMPLOYEES, AGENTS AND/OR REPRESENTATIVES TO CUSTOMER. CUSTOMER ACKNOWLEDGES THAT CUSTOMER DOES NOT RELY AND IS NOT RELYING ON ANY KNOWLEDGE, SKILL, JUDGMENT, EXPERTISE OR EXPERIENCE OF VEYANCE, ITS EMPLOYEES, AGENTS AND/OR REPRESENTATIVES IN CUSTOMER'S SELECTION OF THE PRODUCT OR IN CUSTOMER'S SELECTION, PROVISION OR DESIGNATION OF ANY SPECIFICATION OR SET OF SPECIFICATIONS. Without limiting the foregoing, CUSTOMER ACKNOWLEDGES THAT VEYANCE SHALL NOT BE LIABLE FOR, AND CUSTOMER ASSUMES ALL RISK OF, INACCURATE OR UNSUITABLE SPECIFICATIONS OR INFORMATION PROVIDED, SELECTED OR DESIGNATED BY CUSTOMER.

(4) **LIMITATION OF WARRANTY.** ALL PRODUCTS AND GOODS NOT MANUFACTURED BY VEYANCE ARE SOLD WITHOUT WARRANTY BY VEYANCE, "AS-IS" AND ARE SUBJECT TO THE LIMITATION OF LIABILITY SET FORTH IN SECTION 5. SUBJECT TO THE LIMITATIONS ON LIABILITY SET FORTH IN SECTION 5 AND UNLESS OTHERWISE EXPRESSLY PROVIDED HEREIN, PRODUCTS AND GOODS SOLD HEREUNDER THAT HAVE BEEN MANUFACTURED BY VEYANCE, UNLESS SOLD WITHOUT WARRANTY "AS IS", ARE WARRANTED TO BE FREE FROM DEFECTS IN MATERIAL AND WORKMANSHIP. SUBJECT TO THE PRECEDING SENTENCE, AND EXCEPT AS OTHERWISE EXPRESSLY PROVIDED IN THE AGREEMENT, VEYANCE MAKES NO REPRESENTATION OR WARRANTY OF ANY KIND, EXPRESS OR IMPLIED, AS TO MERCHANTABILITY, FITNESS FOR A PARTICULAR PURPOSE, OR ANY OTHER MATTER WITH RESPECT TO THE PRODUCT OR ANY OTHER PRODUCT SOLD HEREUNDER, WHETHER USED ALONE OR IN COMBINATION WITH ANY OTHER MATERIAL OR PRODUCT OR IN ANY PROCESS. OTHER THAN THOSE SPECIFICALLY SET FORTH HEREIN, THERE ARE NO WARRANTIES WHICH EXTEND BEYOND THE DESCRIPTION OF THE PRODUCTS IN THE AGREEMENT, EITHER EXPRESS OR IMPLIED.

(5) **LIMITATION OF LIABILITY OF VEYANCE AND EXCLUSIVE REMEDY.** ANY VEYANCE-MANUFACTURED PRODUCT OR GOOD CLAIMED TO BE DEFECTIVE IN MATERIAL OR WORKMANSHIP SHALL, UPON VEYANCE'S APPROVAL, BE RETURNED TO VEYANCE AS DESIGNATED BY VEYANCE, AT THE CUSTOMER'S EXPENSE. VEYANCE WILL, AS THE EXCLUSIVE REMEDY FOR BREACH OF WARRANTY OR OTHERWISE UNDER THE AGREEMENT, MAKE AN ADJUSTMENT FOR PRODUCT IT FINDS TO BE DEFECTIVE IN MATERIAL OR WORKMANSHIP EITHER BY REPAIRING IT OR REPLACING IT AT AN ADJUSTMENT PRICE, OR IN LIEU THEREOF, AT VEYANCE'S SOLE DISCRETION AND OPTION, VEYANCE MAY REFUND THE PURCHASE PRICE UPON RETURN OF THE PRODUCT BY CUSTOMER. WHENEVER THE WARRANTY PROVISION IN AN AGREEMENT FOR A SPECIFIC PRODUCT PROVIDES THAT NO ADJUSTMENT SHALL BE MADE AFTER A SPECIFIED PERIOD OF TIME, VEYANCE SHALL NOT BE RESPONSIBLE UNDER THE TERMS OF SUCH WARRANTY UNLESS CLAIM IS MADE WITHIN THE REQUIRED PERIOD OF TIME. VEYANCE'S TOTAL RESPONSIBILITY AND LIABILITY FOR ANY AND ALL CLAIMS, LOSSES AND DAMAGES OF ANY KIND WHATSOEVER ARISING OUT OF ANY CAUSE WHATSOEVER (WHETHER UNDER ANY WARRANTY OR BASED IN CONTRACT, NEGLIGENCE, OTHER TORT, STRICT LIABILITY, BREACH OF WARRANTY, OTHER THEORY UNDER LAW OR EQUITY OR OTHERWISE) SHALL NOT EXCEED THE ORIGINAL PURCHASE PRICE OF THE PRODUCTS IN RESPECT TO WHICH SUCH CAUSE ARISES, AND IN NO EVENT SHALL VEYANCE BE LIABLE FOR SPECIAL, INCIDENTAL, CONSEQUENTIAL, EXEMPLARY, OR PUNITIVE DAMAGES RESULTING FROM ANY SUCH CAUSE. NO EMPLOYEE, AGENT AND/OR REPRESENTATIVE HAS AUTHORITY TO MAKE ANY REPRESENTATION, PROMISE OR AGREEMENT, EXCEPT AS STATED HEREIN. THE PRECEDING SENTENCE SHALL ALSO APPLY TO ANY GOODS OR PRODUCTS SOLD HEREUNDER THAT WERE NOT MANUFACTURED BY VEYANCE. VEYANCE SHALL NOT BE LIABLE FOR, AND CUSTOMER ASSUMES ALL LIABILITY FOR, ALL PERSONAL INJURY AND PROPERTY DAMAGE CONNECTED WITH THE HANDLING, TRANSPORTATION, OR FURTHER MANUFACTURE, FABRICATION, ASSEMBLY, OR PROCESSING OF THE PRODUCT OR ANY OTHER PRODUCT OR GOOD SOLD HEREUNDER.

(6) Prices are subject to change without notice and all such items will be billed at prices in effect at the time of shipment. Customer will be notified of any price increase and may cancel any undelivered portion of the order by written notice to Veyance provided such written notice is received by Veyance not more than 10 days after your receipt of notification of the increase. Upon such cancellation Customer shall have no liability to Veyance for the canceled portion of the order except as to product manufactured or in process, components procured by Veyance from outside sources, and special tooling, equipment or single use raw materials procured for performance of this order.

(7) All prices are subject to increase from time to time to compensate for any tax, excise or levy imposed upon the products sold, or upon the manufacture, sale, transportation, or delivery of them or whenever any tax, excise, levy, law or governmental regulation has the effect, directly or indirectly, of increasing the cost of manufacture, sale or delivery. If any government action or law should have the effect of establishing a maximum price on product to be delivered, Veyance may, at its option and without liability to Customer, terminate its obligation with respect to future shipments upon thirty (30) days written notice.

(8) Veyance shall not be liable or deemed in default for failure to deliver or delay in delivery due to any cause beyond its reasonable control. If unable to meet delivery schedules, Veyance will endeavor to allocate material fairly among its Customers, but reserves to itself final determination of the deliveries to be made without liability.

(9) Veyance will indemnify its Customer against all claims and demands for infringement of any United States patent by the product furnished under any accepted order provided the Customer notifies Veyance of any patent infringement and upon request tenders Veyance the defense of the claim. **CUSTOMERS WHO FURNISH SPECIFICATIONS TO VEYANCE AGREE TO HOLD VEYANCE HARMLESS AND INDEMNIFY VEYANCE AGAINST ANY CLAIMS WHICH ARISE OUT OF VEYANCE'S COMPLIANCE WITH SUCH CUSTOMER SPECIFICATIONS.**

(10) Unless otherwise set forth in the Agreement, all Products sold by Veyance shall be delivered FOB (Veyance's location). Title to the goods shall pass to Customer upon passage of the risk of loss; provided, however, that to the extent permitted by law, until each of the goods delivered hereunder has been paid for in full, Veyance shall retain title to the goods; however, all risk of loss and responsibility for transportation and storage, taxes and duties shall transfer in accordance with the Agreement. Customer hereby agrees that notwithstanding any information shown in this Confirmation regarding any estimated shipment, production or requested date(s) for the goods, Veyance is not obligated to produce, deliver or ship the goods by that estimated shipment, production or requested date(s). Customer hereby agrees that unless Customer notifies Veyance in writing within ninety (90) calendar days of the estimated shipment date as shown on the last dated Confirmation referencing the goods, there shall be a presumption that goods conforming to the goods ordered were received by Customer.

(11) Due to the varying locations of the operations of Customer and Veyance and the locations that may be involved in the performance and documentation of an order to which this Confirmation is applicable, in order to settle upon and to eliminate any doubt as to the rights of the Customer and Veyance, Customer and Veyance agree that this Confirmation and the Agreement shall be governed by and construed in accordance with the laws of the State of Ohio, United States of America, applicable to agreements to be performed in the State of Ohio, except that for sales or orders originating and to be performed in Canada by Canadian subsidiaries or affiliates of Veyance, Customer and Veyance agree that this Confirmation shall be governed by and construed in accordance with the laws of the Province of Ontario, Canada, applicable to agreements to be performed in Canada. Customer and Veyance exclude the application of the United Nations Convention on Contracts for the International Sale of Goods. With regard to any conflict or dispute arising under or related to this Confirmation or the Agreement, Customer hereby submits to the jurisdiction of the state and federal courts located in Summit County, Ohio.